

南京诺金电气有限公司

Nanjing Nowking Electric Co., Ltd

绝缘柱样本



产品名称：绝缘柱

规格型号：RDSC-01

- ◆ MATERIAL: NYLON 66(UL)
- ◆ FLAME CLASS: 94V-2, 94V-0
- ◆ COLOR: BLACK, NATURAL
- ◆ UNIT: mm

用途：用于零件之绝缘用。

RDSC-01 结构图

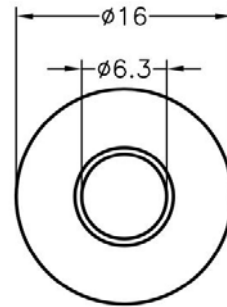
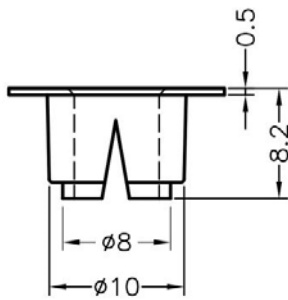

	PART NO	PACKAGE
	RDSC-01	1000

南京诺金电气有限公司

Nanjing Nowking Electric Co., Ltd



产品名称：绝缘柱

规格型号：RDSC-02

◆ MATERIAL: POM(UL)

◆ FLAME CLASS:94HB

◆ COLOR:BLACK

◆ UNIT: mm

用途：用于零件之绝缘用。

RDSC-02 与 RDSC-03 需配合使用

RDSC-02 结构图

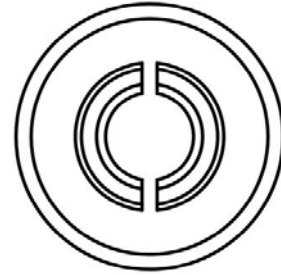
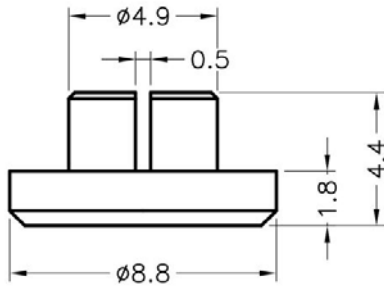

	PART NO	PACKAGE
	RDSC-02	1000

南京诺金电气有限公司

Nanjing Nowking Electric Co., Ltd



产品名称：绝缘柱

规格型号：RDSC-03

◆ MATERIAL: POM(UL)

◆ FLAME CLASS:94HB

◆ COLOR:BLACK

◆ UNIT: mm

用途：用于零件之绝缘用。

RDSC-02 与 RDSC-03 需配合使用

RDSC-03 结构图

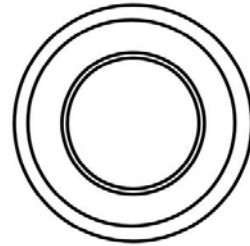
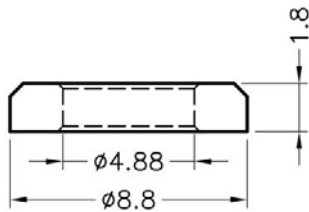

	PART NO	PACKAGE
	RDSC-03	1000

南京诺金电气有限公司

Nanjing Nowking Electric Co., Ltd



产品名称：绝缘柱

规格型号：RDSC-04

- ◆ MATERIAL: NYLON 66(UL)
- ◆ FLAME CLASS: 94V-0, 94V-2
- ◆ COLOR: BLACK, NATURAL
- ◆ UNIT: mm

用途：用于零件之绝缘用。

RDSC-04 结构图

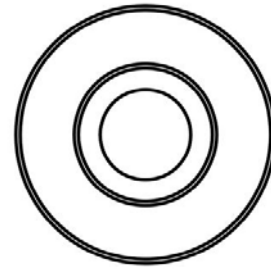
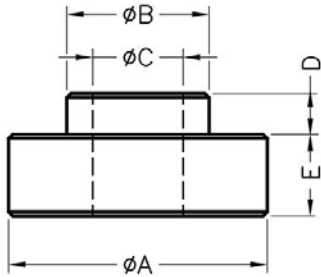

PART NO	A	B	C	D	E	PACKAGE
RDSC-04	12.0	6.6	4.2	1.9	3.8	2000

南京诺金电气有限公司

Nanjing Nowking Electric Co., Ltd



产品名称：绝缘柱

规格型号：RDSC-05

- ◆ MATERIAL: NYLON 66(UL)
- ◆ FLAME CLASS: 94V-0, 94V-2
- ◆ COLOR: BLACK, NATURAL
- ◆ UNIT: mm

用途：用于零件之绝缘用。

RDSC-05 结构图

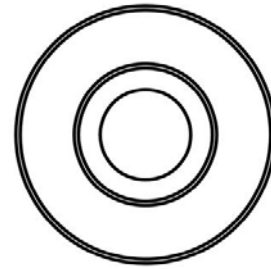
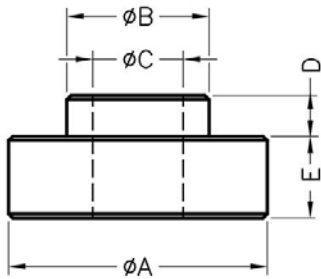

PART NO	A	B	C	D	E	PACKAGE
RDSC-05	7.6	3.9	3.1	4.0	2.0	2000

南京诺金电气有限公司

Nanjing Nowking Electric Co., Ltd



产品名称：绝缘柱

规格型号：RDSC-06

- ◆ MATERIAL: NYLON 66(UL)
- ◆ FLAME CLASS: 94V-0, 94V-2
- ◆ COLOR: BLACK, NATURAL
- ◆ UNIT: mm

用途：用于零件之绝缘用。

RDSC-06 结构图

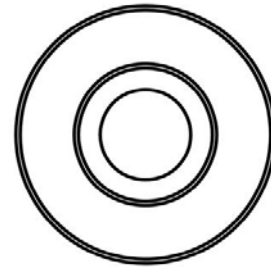
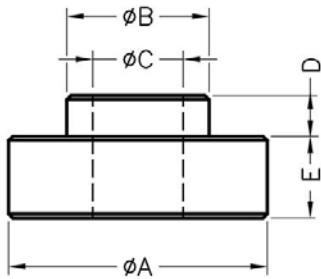

PART NO	A	B	C	D	E	PACKAGE
RDSC-06	14.0	7.6	5.2	2.0	3.0	2000

南京诺金电气有限公司

Nanjing Nowking Electric Co., Ltd



产品名称：绝缘柱

规格型号：RDSC-07

- ◆ MATERIAL: NYLON 66(UL)
- ◆ FLAME CLASS: 94V-0, 94V-2
- ◆ COLOR: BLACK, NATURAL
- ◆ UNIT: mm

用途：用于零件之绝缘用。

RDSC-07 结构图

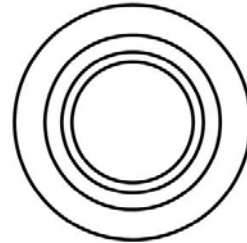
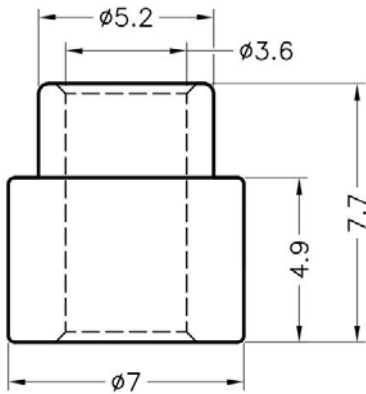

	PART NO	PACKAGE
	RDSC-07	2000

南京诺金电气有限公司

Nanjing Nowking Electric Co., Ltd



产品名称：绝缘柱

规格型号：RDSC-08

- ◆ MATERIAL: NYLON 66(UL)
- ◆ FLAME CLASS: 94V-0, 94V-2
- ◆ COLOR: BLACK, NATURAL
- ◆ UNIT: mm

用途：用于零件之绝缘用。

RDSC-08 结构图

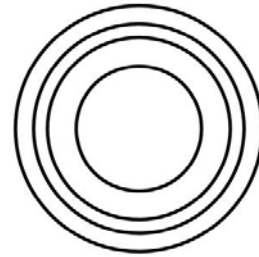
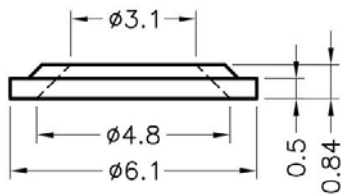

	PART NO	PACKAGE
	RDSC-08	2000

南京诺金电气有限公司

Nanjing Nowking Electric Co., Ltd



产品名称：绝缘柱

规格型号：RDSC-09

- ◆ MATERIAL: PC (UL)
- ◆ FLAME CLASS: 94V-2
- ◆ COLOR: BLACK
- ◆ UNIT: mm

用途：用于零件之绝缘用。

RDSC-09 结构图

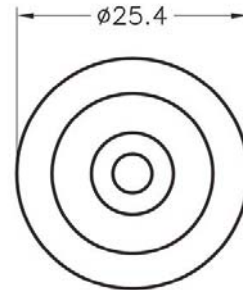
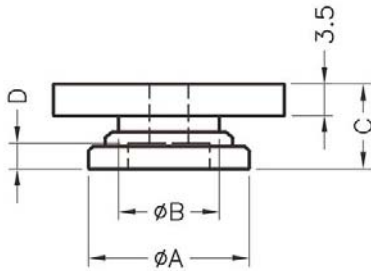

	PART NO	A	B	C	D	PACKAGE
	RDSC-09	17.67	11.07	1.79	3.0	1000

南京诺金电气有限公司

Nanjing Nowking Electric Co., Ltd



产品名称：绝缘柱

规格型号：RDSC-10

- ◆ MATERIAL: PC(UL)
- ◆ FLAME CLASS:94V-2
- ◆ COLOR:NATURAL
- ◆ UNIT: mm

用途：用于零件之绝缘用。

RDSC-10 结构图

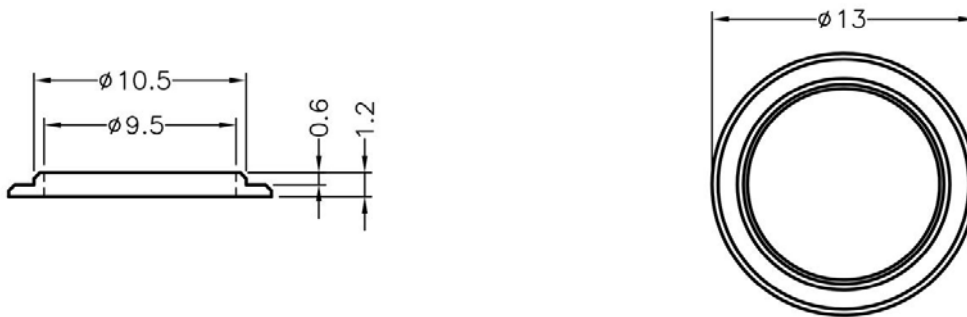

	PART NO	PACKAGE
	RDSC-10	1000

南京诺金电气有限公司

Nanjing Nowking Electric Co., Ltd



产品名称：绝缘柱

规格型号：RDSC-11

◆ MATERIAL: NYLON 46, PPS(UL)

◆ FLAME CLASS:94V-0

◆ COLOR:NATURAL

◆ UNIT: mm

用途：用于 M3 螺母之绝缘使用。

RDSC-11 结构图

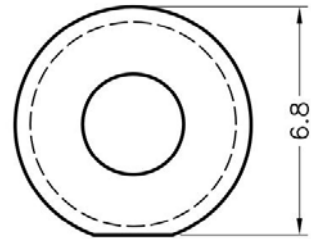
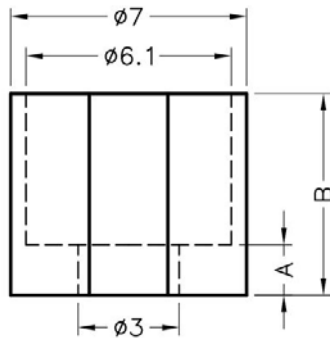

	PART NO	A	B	PACKAGE
	RDSC-11	1.5	6.0	2000

南京诺金电气有限公司

Nanjing Nowking Electric Co., Ltd



产品名称：绝缘柱

规格型号：RDSC-12

◆ MATERIAL: NYLON 46, PPS(UL)

◆ FLAME CLASS:94V-0

◆ COLOR:NATURAL

◆ UNIT: mm

用途：用于 M3 螺母之绝缘使用。

RDSC-12 结构图

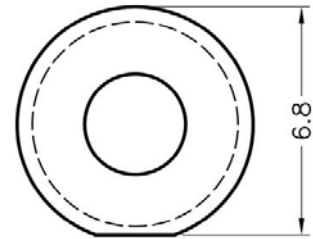
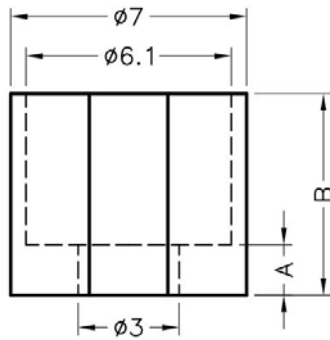

	PART NO	A	B	PACKAGE
	RDSC-12	1.4	3.5	2000

南京诺金电气有限公司

Nanjing Nowking Electric Co., Ltd



产品名称：绝缘柱

规格型号：RDSC-13

◆ MATERIAL: NYLON 46(UL),PPS(UL)

◆ FLAME CLASS:94V-0

◆ COLOR:NATURAL

◆ UNIT: mm

用途：用于 M3 螺母之绝缘使用。

RDSC-13 结构图

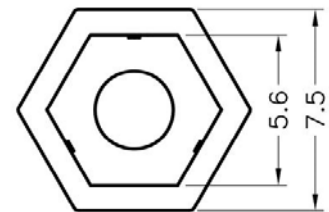
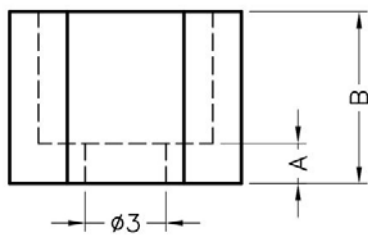

	PART NO	A	B	PACKAGE
	RDSC-13	1.5	6.4	2000

南京诺金电气有限公司

Nanjing Nowking Electric Co., Ltd



产品名称：绝缘柱

规格型号：RDSC-14

◆ MATERIAL: NYLON 46(UL),PPS(UL)

◆ FLAME CLASS:94V-0

◆ COLOR:NATURAL

◆ UNIT: mm

用途：用于 M3 螺母之绝缘使用。

RDSC-14 结构图

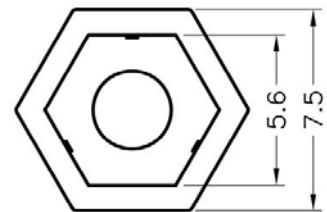
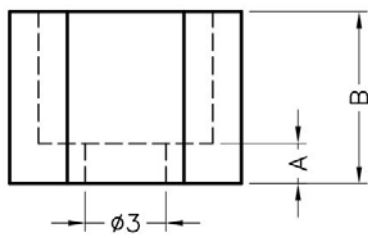

	PART NO	A	B	PACKAGE
	RDSC-14	0.8	5.2	2000

南京诺金电气有限公司

Nanjing Nowking Electric Co., Ltd

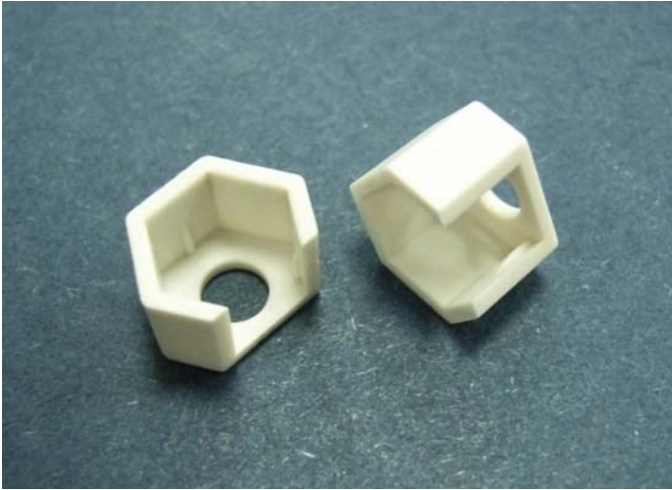

产品名称：绝缘柱

规格型号：RDSC-15

◆ MATERIAL: NYLON 46(UL)

◆ FLAME CLASS:94V-0

◆ COLOR:NATURAL

◆ UNIT: mm

用途：用于 M3 螺母之绝缘使用。

RDSC-15 结构图

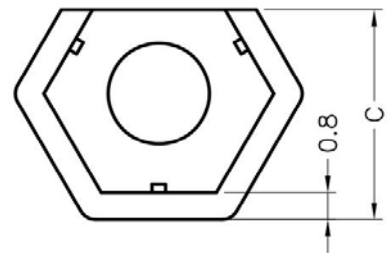
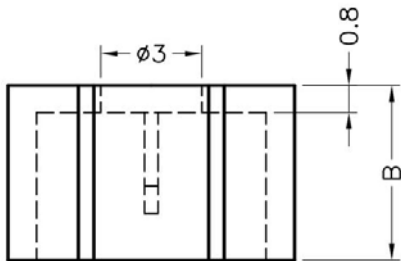

	PART NO	B	C	PACKAGE
	RDSC-15	5.2	6.25	2000

南京诺金电气有限公司

Nanjing Nowking Electric Co., Ltd



产品名称：绝缘柱

规格型号：RDSC-16

◆ MATERIAL: NYLON 46(UL)

◆ FLAME CLASS:94V-0

◆ COLOR:NATURAL

◆ UNIT: mm

用途：用于 M3 螺母之绝缘使用。

RDSC-16 结构图

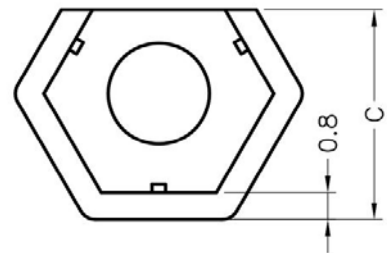
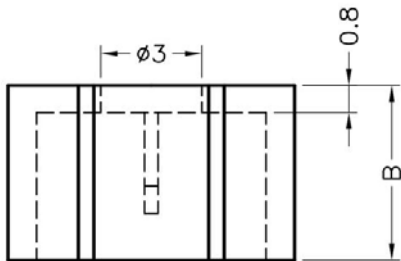

	PART NO	B	C	PACKAGE
	RDSC-16	4.0	5.8	2000

南京诺金电气有限公司

Nanjing Nowking Electric Co., Ltd



产品名称：绝缘柱

规格型号：RDSC-17

◆ MATERIAL: NYLON 46(UL)

◆ FLAME CLASS:94V-0

◆ COLOR:NATURAL

◆ UNIT: mm

用途：用于 M3 螺母之绝缘使用。

RDSC-17 结构图

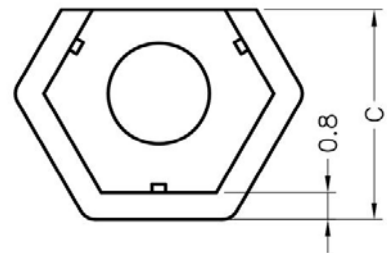
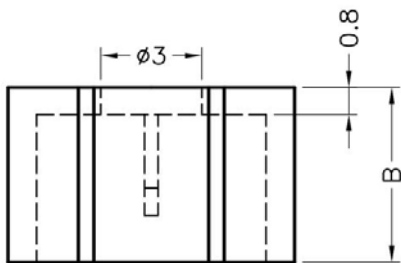

	PART NO	B	C	PACKAGE
	RDSC-17	4.0	6.25	2000

南京诺金电气有限公司

Nanjing Nowking Electric Co., Ltd



产品名称：绝缘柱

规格型号：RDSC-18

◆ MATERIAL: NYLON 46, PPS(UL)

◆ FLAME CLASS: 94V-0

◆ COLOR: NATURAL

◆ UNIT: mm

用途：用于 M3 螺母之绝缘使用。

RDSC-18 结构图

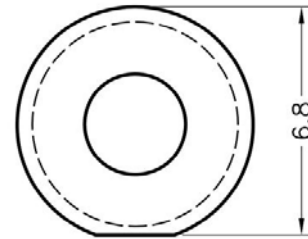
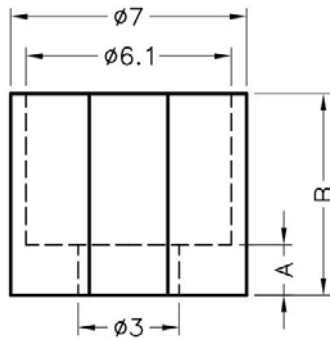

	PART NO	A	B	PACKAGE
	RDSC-18	0.8	3.8	2000

南京诺金电气有限公司

Nanjing Nowking Electric Co., Ltd



产品名称：绝缘柱

规格型号：RDSC-19

◆ MATERIAL: NYLON 46, PPS(UL)

◆ FLAME CLASS:94V-0

◆ COLOR:NATURAL

◆ UNIT: mm

用途：用于 M3 螺母之绝缘使用。

RDSC-19 结构图

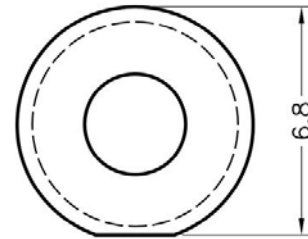
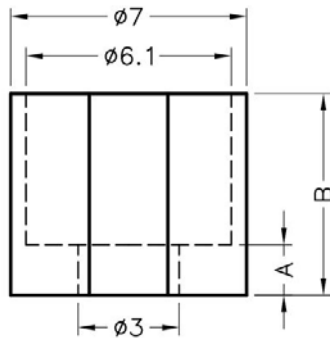

	PART NO	A	B	PACKAGE
	RDSC-19	0.3	2.3	2000

南京诺金电气有限公司

Nanjing Nowking Electric Co., Ltd



产品名称：绝缘柱

规格型号：RDSC-20

◆ MATERIAL: NYLON 46, PPS(UL)

◆ FLAME CLASS:94V-0

◆ COLOR:NATURAL

◆ UNIT: mm

用途：用于 M3 螺母之绝缘使用。

RDSC-20 结构图

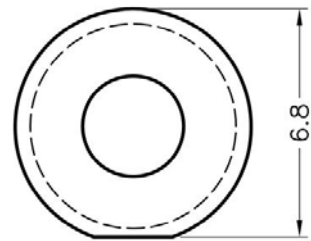
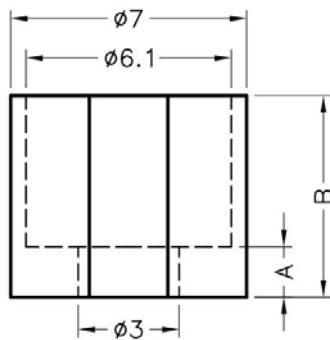

	PART NO	A	B	PACKAGE
	RDSC-20	0.3	2.3	2000

南京诺金电气有限公司

Nanjing Nowking Electric Co., Ltd



产品名称：绝缘柱

规格型号：RDSC-21

◆ MATERIAL: NYLONG 66(UL)

◆ FLAME CLASS:94V-0

◆ COLOR:NATURAL,BLACK

◆ UNIT: mm

用途：用于零件之绝缘用。

RDSC-21 结构图

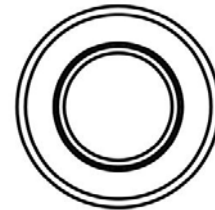
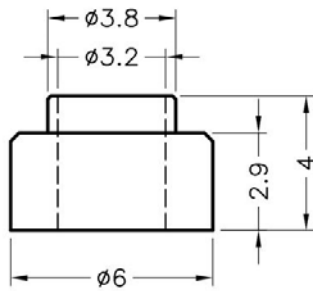

	PART NO	PACKAGE
	RDSC-21	2000

南京诺金电气有限公司

Nanjing Nowking Electric Co., Ltd



产品名称：绝缘柱

规格型号：RDSC-22

◆ MATERIAL: NYLON 46, PPS(UL)

◆ FLAME CLASS:94V-0

◆ COLOR:NATURAL

◆ UNIT: mm

用途：用于 M3 螺母之绝缘使用。

RDSC-22 结构图

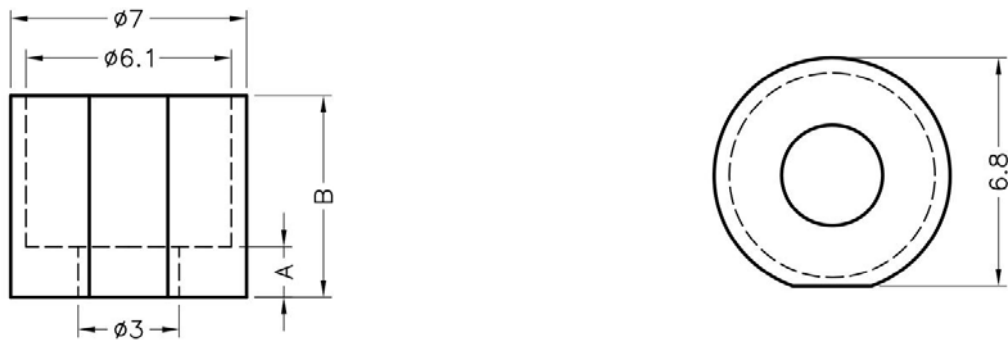

	PART NO	A	B	PACKAGE
	RDSC-22	0.3	1.9	2000

南京诺金电气有限公司

Nanjing Nowking Electric Co., Ltd



产品名称：绝缘柱

规格型号：RDSC-23

◆ MATERIAL: NYLON 66(UL)

◆ FLAME CLASS:94V-2

◆ COLOR:BLACK

◆ UNIT: mm

用途：用于零件之绝缘用。

RDSC-23 结构图

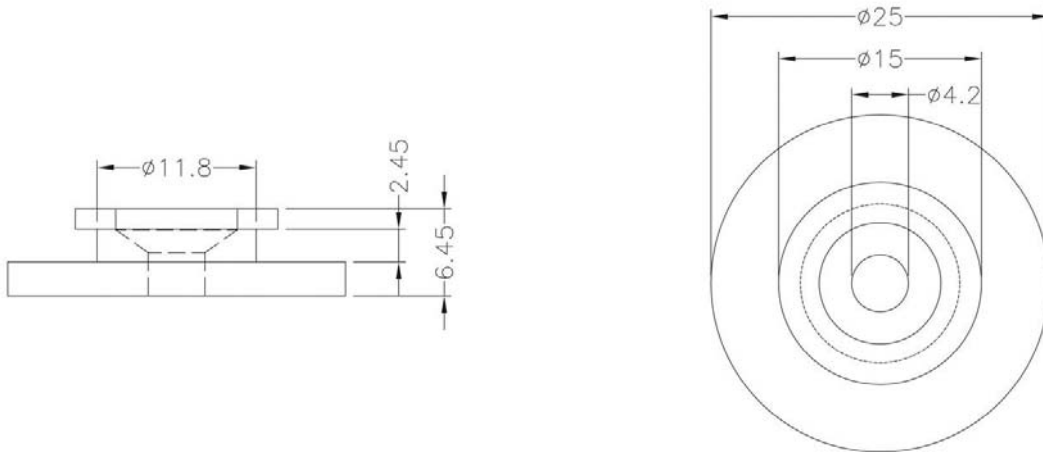

	PART NO	PACKAGE
	RDSC-23	1000

南京诺金电气有限公司

Nanjing Nowking Electric Co., Ltd



产品名称：绝缘柱

规格型号：RDSC-24

◆ MATERIAL: NYLON 66(UL)

◆ FLAME CLASS: 94V-2, 94V-0

◆ COLOR: BLACK, NATURAL

◆ UNIT: mm

用途：用于零件之绝缘用。

可使用同等材质

所有尺寸量测皆不含进胶口,胶口凸出 0.3mm 之内

RDSC-24 结构图

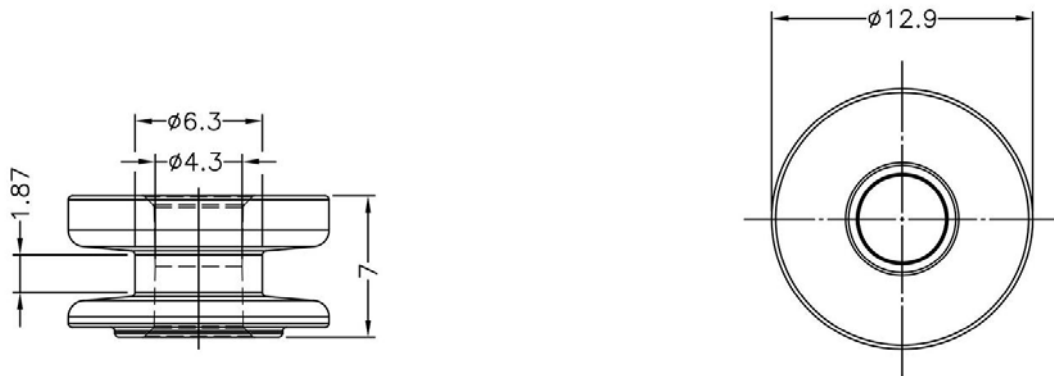

	PART NO	PACKAGE
	RDSC-24	1000

南京诺金电气有限公司

Nanjing Nowking Electric Co., Ltd

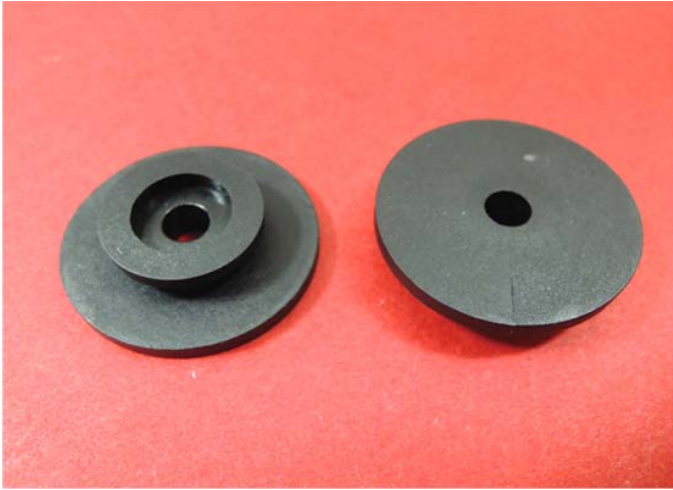

产品名称：绝缘柱

规格型号：RDSC-25

- ◆ MATERIAL 1: POM
- ◆ COLOR 1: BLACK
- ◆ MATERIAL 2: PBT(UL)
- ◆ FLAME CLASS 2:94V-0
- ◆ COLOR 2:BLACK
- ◆ UNIT: mm

用途：用于零件之绝缘用。

可使用同等材质

所有尺寸量测皆不含进胶口,胶口凸出 0.3mm 之内

RDSC-25 结构图

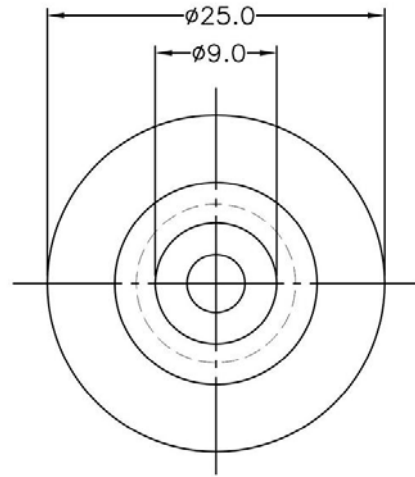
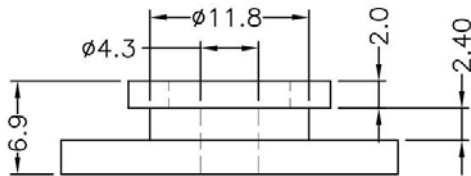

	PART NO	PACKAGE
	RDSC-25	1000

南京诺金电气有限公司

Nanjing Nowking Electric Co., Ltd



产品名称：绝缘柱

规格型号：RDSC-26

- ◆ MATERIAL: PBT(UL)
- ◆ FLAME CLASS: 94V-0
- ◆ COLOR: BLACK, NATURAL
- ◆ UNIT: mm

用途：做为 PC 板与机板之绝缘用。

可使用同等材质

RDSC-26 结构图

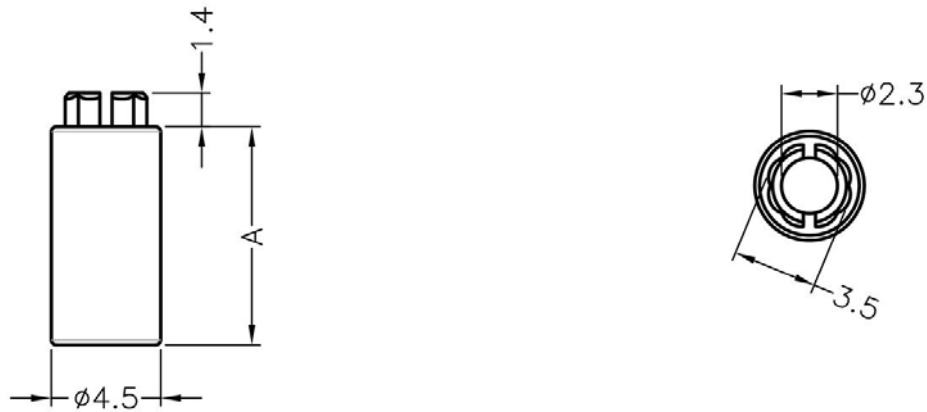

	PART NO	A	PACKAGE
	RDSC-26	9.0	1000

南京诺金电气有限公司

Nanjing Nowking Electric Co., Ltd



产品名称：绝缘柱

规格型号：RDSC-27

- ◆ MATERIAL: PC(UL)
- ◆ FLAME CLASS:94V-0,94V-2
- ◆ COLOR:NATURAL
- ◆ UNIT: mm

用途：做为 PC 板与机板之绝缘用。

RDSC-27 结构图

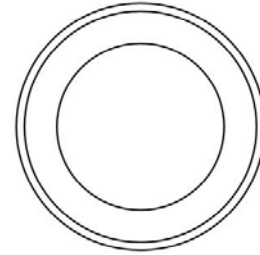
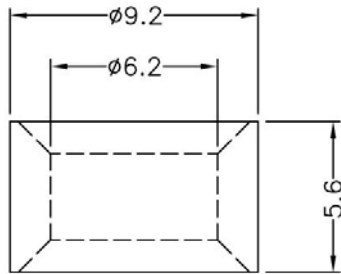

	PART NO	PACKAGE
	RDSC-27	1000

南京诺金电气有限公司

Nanjing Nowking Electric Co., Ltd



产品名称：绝缘柱

规格型号：RDSC-28

◆ MATERIAL: NYLON 6T

◆ COLOR: BLACK

◆ UNIT: mm

用途：作为螺丝与机板之绝缘用。

RDSC-28 结构图

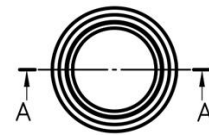
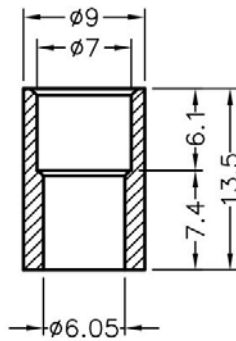

	PART NO	PACKAGE
	RDSC-28	1000

南京诺金电气有限公司

Nanjing Nowking Electric Co., Ltd



产品名称：绝缘柱

规格型号：RDSC-29

◆ MATERIAL: NYLON 66(UL)

◆ FLAME GLASS:94V-2

◆ COLOR:NATURAL

◆ UNIT: mm

用途：做为 PC 板与机板之绝缘用。

RDSC-29 结构图

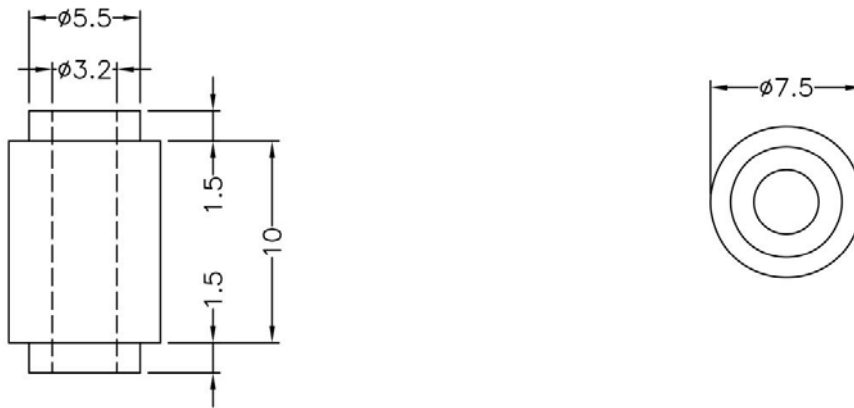

	PART NO	PACKAGE
	RDSC-29	1000

南京诺金电气有限公司

Nanjing Nowking Electric Co., Ltd



产品名称：绝缘柱

规格型号：RDSC-30

◆ MATERIAL: ABS(UL)

◆ FLAME GLASS:94HB

◆ COLOR:NATURAL

◆ UNIT: mm

用途：作为 PC 板与机板之绝缘用。

RDSC-30 结构图



	PART NO	PACKAGE
	RDSC-30	1000

南京诺金电气有限公司

Nanjing Nowking Electric Co., Ltd



产品名称：绝缘柱

规格型号：RDSC-31

- ◆ MATERIAL: PC (UL)
- ◆ FLAME CLASS: 94V-2
- ◆ COLOR: BLACK
- ◆ UNIT: mm

用途：用于零件之绝缘用。

RDSC-31 结构图

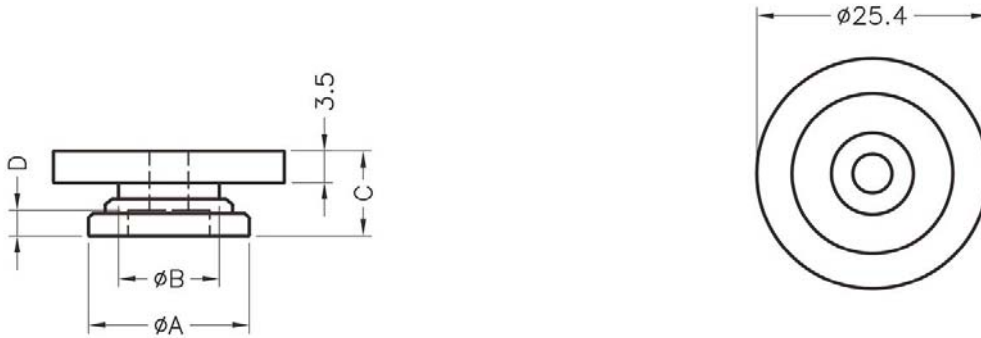

	PART NO	A	B	C	D	PACKAGE
	RDSC-31	17.7	11.0	1.95	2.8	1000

南京诺金电气有限公司

Nanjing Nowking Electric Co., Ltd



产品名称：绝缘柱

规格型号：RDSC-32

- ◆ MATERIAL: PBT (UL)
- ◆ FLAME CLASS: 94V-0
- ◆ COLOR: BLACK, NATURAL
- ◆ UNIT: mm

用途：作为 PC 板与机板之绝缘用。

RDSC-32 结构图

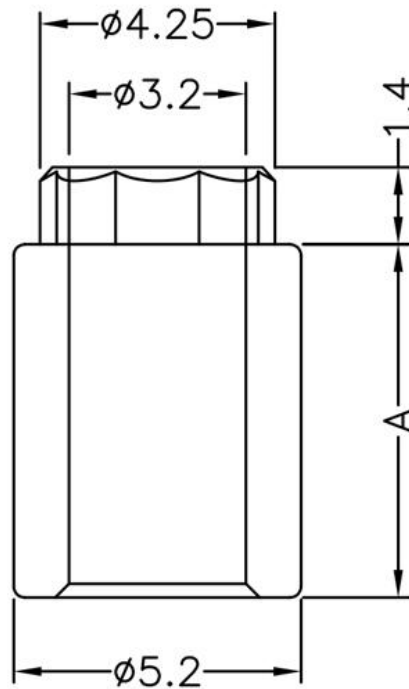

	PART NO	A	PACKAGE
	RDSC-32	6.4	1000

南京诺金电气有限公司

Nanjing Nowking Electric Co., Ltd



产品名称：绝缘柱

规格型号：RDSC-33

◆ MATERIAL: NYLON 66 (UL)

◆ FLAME CLASS: 94V-2, 94V-0

◆ COLOR: BLACK, NATURAL

◆ UNIT: mm

用途：作为 PC 板与机板之绝缘用。

RDSC-33 结构图

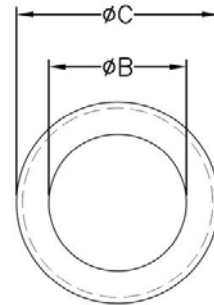
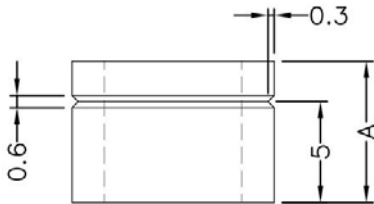

	PART NO	A	B	C	PACKAGE
	RDSC-33	7.0	Ø6.8	Ø10.0	1000

南京诺金电气有限公司

Nanjing Nowking Electric Co., Ltd



产品名称：绝缘柱

规格型号：RDSC-34

- ◆ MATERIAL: NYLON 66(UL)
- ◆ FLAME GLASS: 94V-0, 94V-2
- ◆ COLOR: NATURAL, BLACK
- ◆ UNIT: mm

用途：用于零件之绝缘使用。

可使用同等材质

所有尺寸量测皆不含进胶口,胶口凸出 0.3mm 之内

RDSC-34 结构图

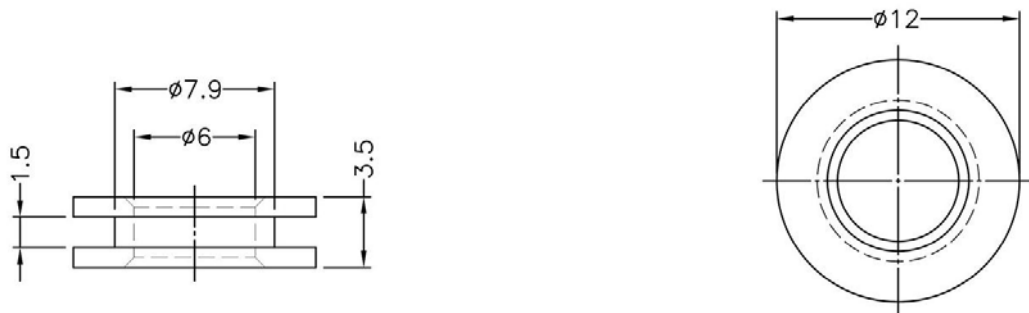

	PART NO	PACKAGE
	RDSC-34	1000

南京诺金电气有限公司

Nanjing Nowking Electric Co., Ltd

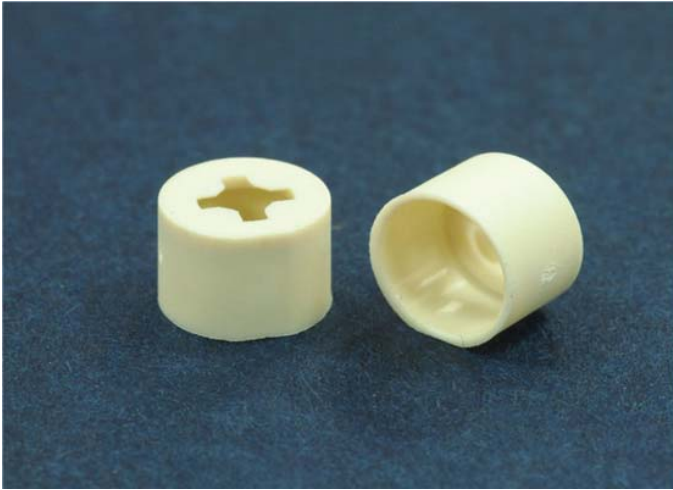

产品名称：绝缘柱

规格型号：RDSC-35

◆ MATERIAL: NYLON 46(UL)

◆ FLAME GLASS:94V-0

◆ COLOR:NATURAL

◆ UNIT: mm

用途：用于 M3 螺丝或螺母之绝缘使用。

可使用同等材质

RDSC-35 结构图

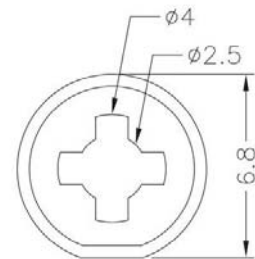
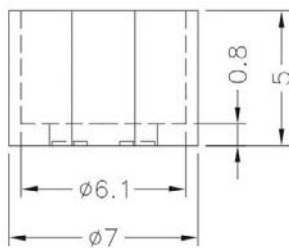

	PART NO	PACKAGE
	RDSC-35	1000

南京诺金电气有限公司

Nanjing Nowking Electric Co., Ltd



产品名称：绝缘柱

规格型号：RDSC-36

◆ MATERIAL: NYLON 66(UL),PC(UL)

◆ FLAME GLASS:94V-0,94V-2

◆ COLOR:NATURAL,BLACK

◆ UNIT: mm

用途：作为 PC 板与机板之绝缘用。

RDSC-36 结构图

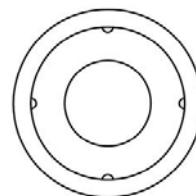
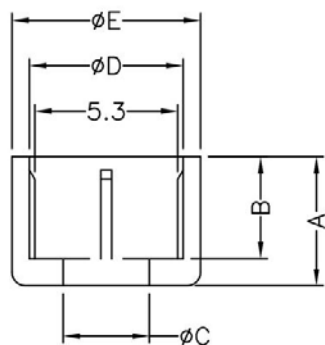

	PART NO	A	B	C	D	E	PACKAGE
	RDSC-36	4.9	3.8	3.2	5.7	7.0	2000

南京诺金电气有限公司

Nanjing Nowking Electric Co., Ltd



产品名称：绝缘柱

规格型号：RDSC-37

◆ MATERIAL: NYLON 66(UL),PC(UL)

◆ FLAME GLASS:94V-0,94V-2

◆ COLOR:NATURAL,BLACK

◆ UNIT: mm

用途：作为 PC 板与机板之绝缘用。

RDSC-37 结构图

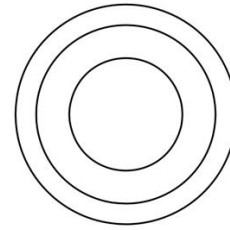
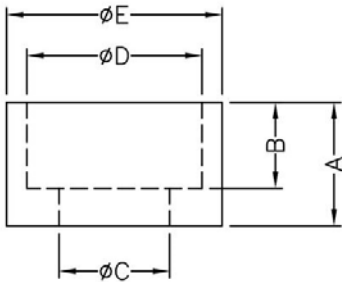

PART NO	A	B	C	D	E	PACKAGE
RDSC-37	4.6	3.2	4.1	6.5	8.0	2000

南京诺金电气有限公司

Nanjing Nowking Electric Co., Ltd



产品名称：绝缘柱

规格型号：RDSC-38

◆ MATERIAL: NYLON 66(UL),PC(UL)

◆ FLAME GLASS:94V-0,94V-2

◆ COLOR:NATURAL,BLACK

◆ UNIT: mm

用途：作为 PC 板与机板之绝缘用。

RDSC-38 结构图

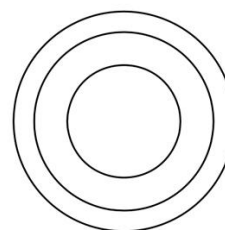
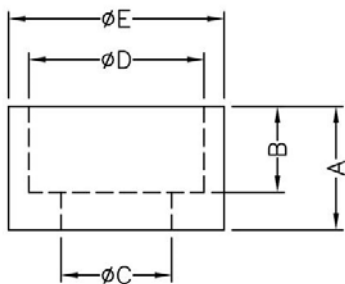

	PART NO	A	B	C	D	E	PACKAGE
	RDSC-38	10.0	7.0	3.0	8.5	11.0	1000

南京诺金电气有限公司

Nanjing Nowking Electric Co., Ltd

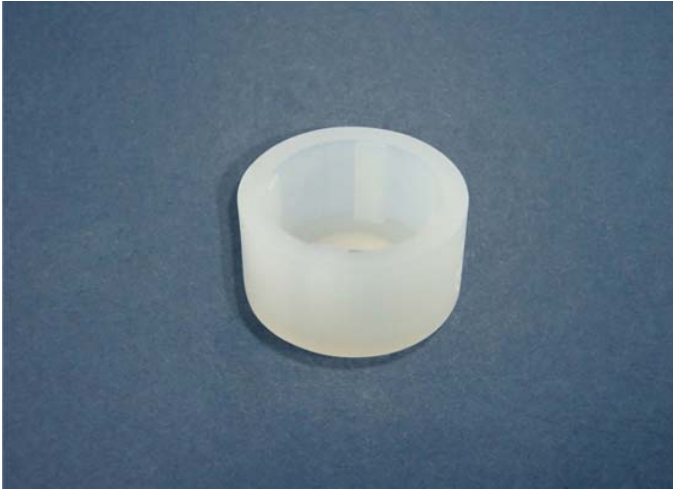

产品名称：绝缘柱

规格型号：RDSC-39

◆ MATERIAL: NYLON 66(UL),PC(UL)

◆ FLAME GLASS:94V-0,94V-2

◆ COLOR:NATURAL,BLACK

◆ UNIT: mm

用途：作为 PC 板与机板之绝缘用。

RDSC-39 结构图

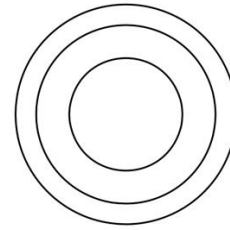
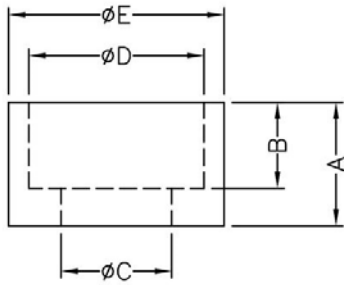

	PART NO	A	B	C	D	E	PACKAGE
	RDSC-39	3.1	2.1	3.0	5.5	7.5	2000

南京诺金电气有限公司

Nanjing Nowking Electric Co., Ltd



产品名称：绝缘柱

规格型号：RDSC-40

◆ MATERIAL: NYLON 66(UL),PC(UL)

◆ FLAME GLASS:94V-0,94V-2

◆ COLOR:NATURAL,BLACK

◆ UNIT: mm

用途：作为 PC 板与机板之绝缘用。

RDSC-40 结构图

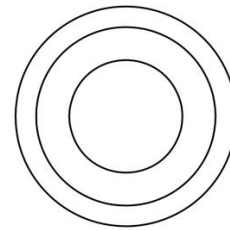
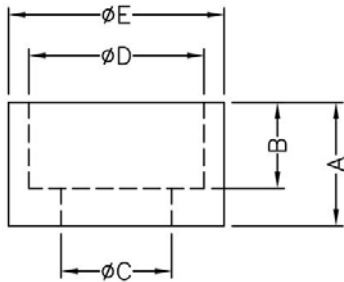

	PART NO	A	B	C	D	E	PACKAGE
	RDSC-40	3.0	1.5	3.7	7.4	9.4	2000

南京诺金电气有限公司

Nanjing Nowking Electric Co., Ltd



产品名称：绝缘柱

规格型号：RDSC-41

◆ MATERIAL: NYLON 66(UL),PC(UL)

◆ FLAME GLASS:94V-0,94V-2

◆ COLOR:NATURAL,BLACK

◆ UNIT: mm

用途：作为 PC 板与机板之绝缘用。

RDSC-41 结构图

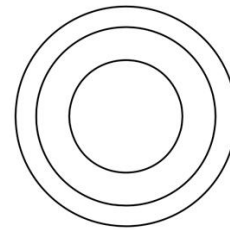
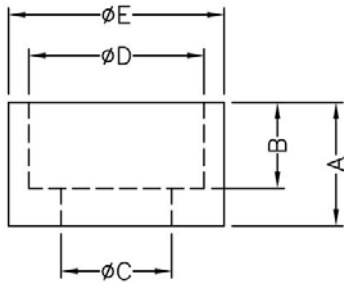

	PART NO	A	B	C	D	E	PACKAGE
	RDSC-41	4.6	3.6	3.6	7.6	9.1	2000

南京诺金电气有限公司

Nanjing Nowking Electric Co., Ltd



产品名称：绝缘柱

规格型号：RDSC-42

◆ MATERIAL: NYLON 66(UL),PC(UL)

◆ FLAME GLASS:94V-0,94V-2

◆ COLOR:NATURAL,BLACK

◆ UNIT: mm

用途：作为 PC 板与机板之绝缘用。

RDSC-42 结构图

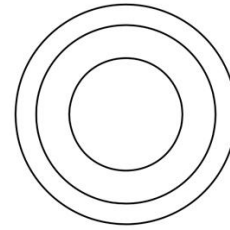
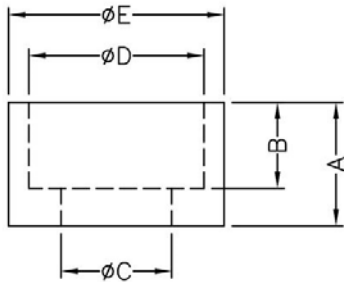

	PART NO	A	B	C	D	E	PACKAGE
	RDSC-42	4.0	3.0	2.9	6.3	7.8	2000

南京诺金电气有限公司

Nanjing Nowking Electric Co., Ltd



产品名称：绝缘柱

规格型号：RDSC-43

◆ MATERIAL: NYLON 66(UL),PC(UL)

◆ FLAME GLASS:94V-0,94V-2

◆ COLOR:NATURAL,BLACK

◆ UNIT: mm

用途：作为 PC 板与机板之绝缘用。

RDSC-43 结构图

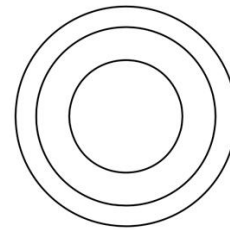
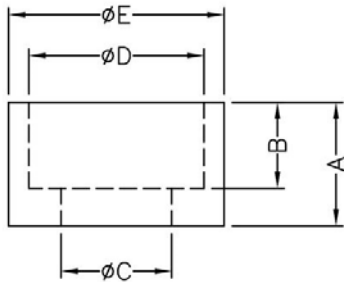

	PART NO	A	B	C	D	E	PACKAGE
	RDSC-43	4.2	2.7	3.2	5.3	8.74	2000

南京诺金电气有限公司

Nanjing Nowking Electric Co., Ltd



产品名称：绝缘柱

规格型号：RDSC-44

◆ MATERIAL: NYLON 66(UL),PC(UL)

◆ FLAME GLASS:94V-0,94V-2

◆ COLOR:NATURAL,BLACK

◆ UNIT: mm

用途：作为 PC 板与机板之绝缘用。

RDSC-44 结构图

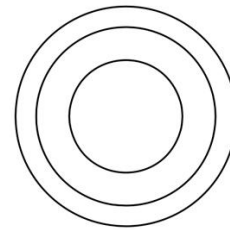
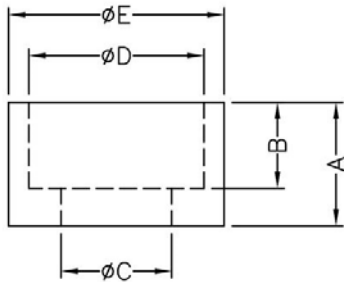

PART NO	A	B	C	D	E	PACKAGE
RDSC-44	6.5	6.0	6.0	8.0	9.0	2000

南京诺金电气有限公司

Nanjing Nowking Electric Co., Ltd



产品名称：绝缘柱

规格型号：RDSC-45

◆ MATERIAL: NYLON 66(UL),PC(UL)

◆ FLAME GLASS:94V-0,94V-2

◆ COLOR:NATURAL,BLACK

◆ UNIT: mm

用途：作为 PC 板与机板之绝缘用。

RDSC-45 结构图

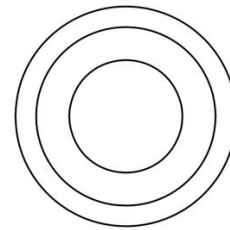
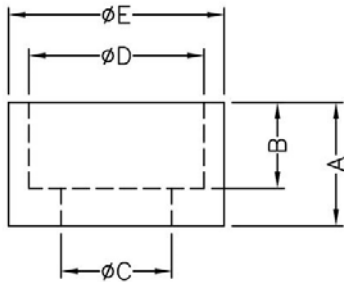

PART NO	A	B	C	D	E	PACKAGE
RDSC-45	7.1	5.1	4.8	8.9	15.7	2000

南京诺金电气有限公司

Nanjing Nowking Electric Co., Ltd

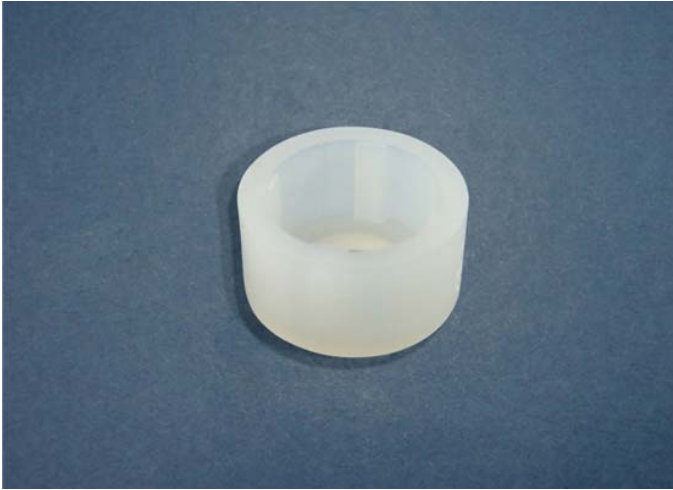

产品名称：绝缘柱

规格型号：RDSC-46

◆ MATERIAL: NYLON 66(UL),PC(UL)

◆ FLAME GLASS:94V-0,94V-2

◆ COLOR:NATURAL,BLACK

◆ UNIT: mm

用途：作为 PC 板与机板之绝缘用。

RDSC-46 结构图

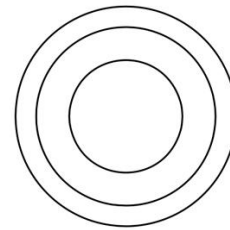
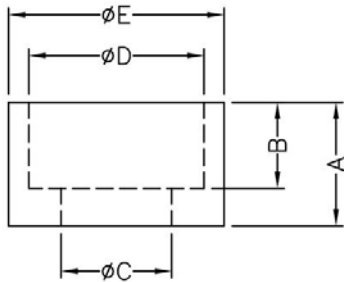

	PART NO	A	B	C	D	E	PACKAGE
	RDSC-46	5.1	4.0	7.0	10.0	12.0	1000

南京诺金电气有限公司

Nanjing Nowking Electric Co., Ltd



产品名称：绝缘柱

规格型号：RDSC-47

◆ MATERIAL: NYLON 66(UL),PC(UL)

◆ FLAME GLASS:94V-0,94V-2

◆ COLOR:NATURAL,BLACK

◆ UNIT: mm

用途：作为 PC 板与机板之绝缘用。

RDSC-47 结构图

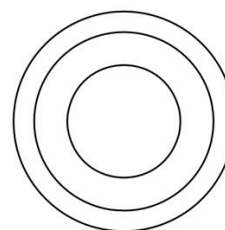
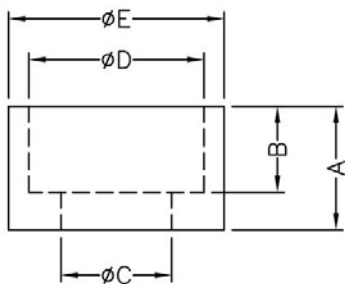

	PART NO	A	B	C	D	E	PACKAGE
	RDSC-47	3.8	2.25	3.4	5.95	8.0	2000

南京诺金电气有限公司

Nanjing Nowking Electric Co., Ltd



产品名称：绝缘柱

规格型号：RDSC-48

◆ MATERIAL: NYLON 66(UL),PC(UL)

◆ FLAME GLASS:94V-0,94V-2

◆ COLOR:NATURAL,BLACK

◆ UNIT: mm

用途：作为 PC 板与机板之绝缘用。

RDSC-48 结构图

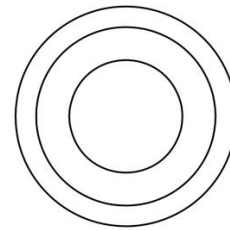
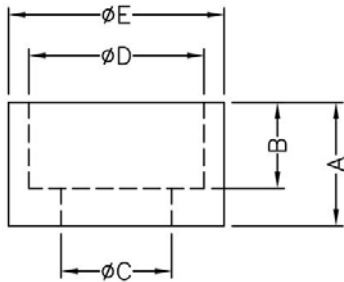

	PART NO	A	B	C	D	E	PACKAGE
	RDSC-48	4.8	3.3	3.4	6.5	9.5	2000

南京诺金电气有限公司

Nanjing Nowking Electric Co., Ltd



产品名称：绝缘柱

规格型号：RDSC-49

◆ MATERIAL: NYLON 66(UL),PC(UL)

◆ FLAME GLASS:94V-0,94V-2

◆ COLOR:NATURAL,BLACK

◆ UNIT: mm

用途：作为 PC 板与机板之绝缘用。

RDSC-49 结构图

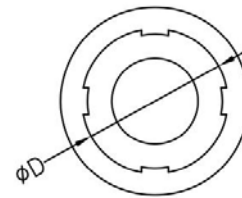
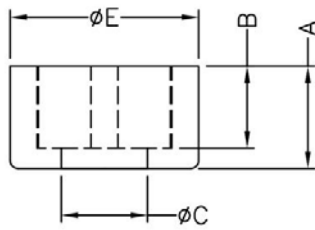

	PART NO	A	B	C	D	E	PACKAGE
	RDSC-49	3.8	3.05	3.2	5.4	7.0	2000

南京诺金电气有限公司

Nanjing Nowking Electric Co., Ltd



产品名称：绝缘柱

规格型号：RDSC-50

◆ MATERIAL: NYLON 66(UL),PC(UL)

◆ FLAME GLASS:94V-0,94V-2

◆ COLOR:NATURAL,BLACK

◆ UNIT: mm

用途：作为 PC 板与机板之绝缘用。

RDSC-50 结构图

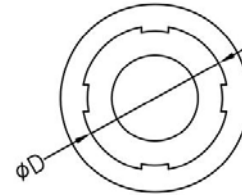
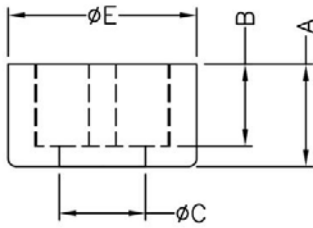

	PART NO	A	B	C	D	E	PACKAGE
	RDSC-50	6.4	3.4	3.2	5.0	7.0	2000

南京诺金电气有限公司

Nanjing Nowking Electric Co., Ltd



产品名称：绝缘柱

规格型号：RDSC-51

◆ MATERIAL: NYLON 66(UL),PC(UL)

◆ FLAME GLASS:94V-0,94V-2

◆ COLOR:NATURAL,BLACK

◆ UNIT: mm

用途：作为 PC 板与机板之绝缘用。

RDSC-51 结构图

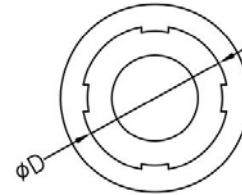
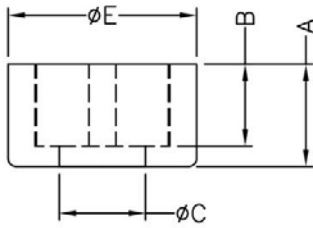

	PART NO	A	B	C	D	E	PACKAGE
	RDSC-51	6.0	3.0	2.8	5.0	7.5	2000

南京诺金电气有限公司

Nanjing Nowking Electric Co., Ltd



产品名称：绝缘柱

规格型号：RDSC-52

◆ MATERIAL: NYLON 66(UL),PC(UL)

◆ FLAME GLASS:94V-0,94V-2

◆ COLOR:NATURAL,BLACK

◆ UNIT: mm

用途：作为 PC 板与机板之绝缘用。

RDSC-52 结构图

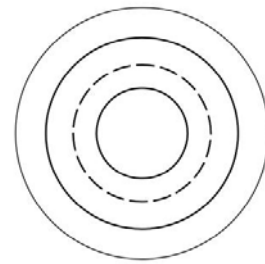
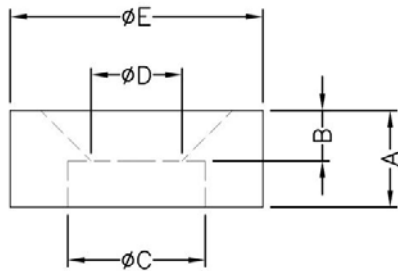

	PART NO	A	B	C	D	E	PACKAGE
	RDSC-52	4.8	2.5	6.8	4.5	12.5	2000

南京诺金电气有限公司

Nanjing Nowking Electric Co., Ltd



产品名称：绝缘柱

规格型号：RDSC-53

◆ MATERIAL: NYLON 66(UL),PC(UL)

◆ FLAME GLASS:94V-0,94V-2

◆ COLOR:NATURAL,BLACK

◆ UNIT: mm

用途：作为 PC 板与机板之绝缘用。

RDSC-53 结构图

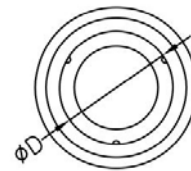
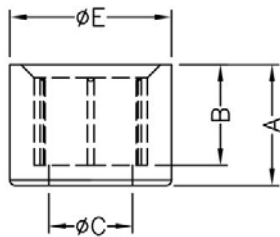

	PART NO	A	B	C	D	E	PACKAGE
	RDSC-53	4.5	3.75	3.1	4.2	6.0	2000

南京诺金电气有限公司

Nanjing Nowking Electric Co., Ltd



产品名称：绝缘柱

规格型号：RDSC-54

◆ MATERIAL: NYLON 46(UL),PPS(UL)

◆ FLAME GLASS:94V-0

◆ COLOR:NATURAL,BLACK

◆ UNIT: mm

用途：作为 PC 板与机板之绝缘用。

RDSC-54 结构图

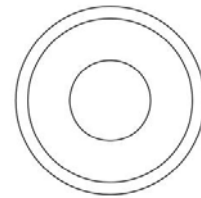
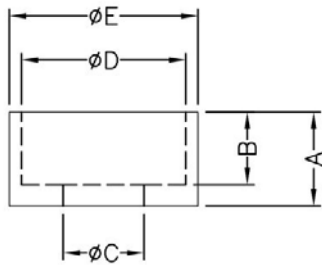

	PART NO	A	B	C	D	E	PACKAGE
	RDSC-54	3.5	2.7	3.0	6.1	7.0	2000

南京诺金电气有限公司

Nanjing Nowking Electric Co., Ltd

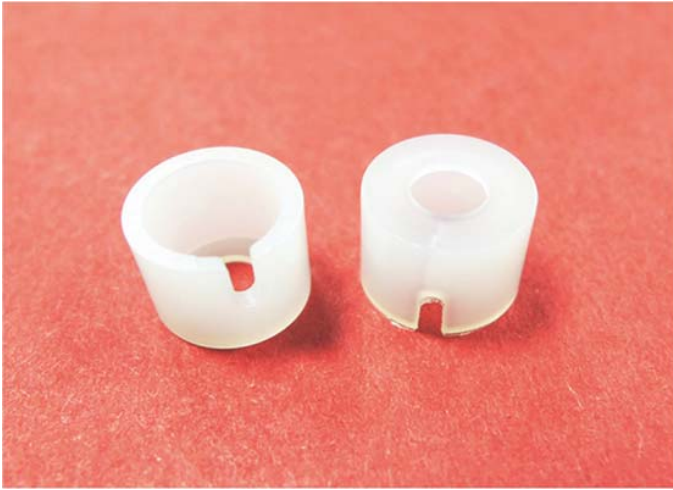

产品名称：绝缘柱

规格型号：RDSC-55

◆ MATERIAL: NYLON 66(UL),PC(UL)

◆ FLAME GLASS:94V-0

◆ COLOR:NATURAL,BLACK

◆ UNIT: mm

用途：作为 PC 板与机板之绝缘用。

RDSC-55 结构图

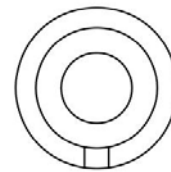
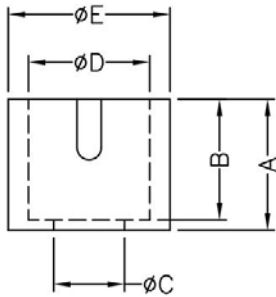

	PART NO	A	B	C	D	E	PACKAGE
	RDSC-55	6.5	6.0	3.5	6.0	8.0	2000

南京诺金电气有限公司

Nanjing Nowking Electric Co., Ltd



产品名称：绝缘柱

规格型号：RDSC-56

◆ MATERIAL: NYLON 66(UL)

◆ FLAME GLASS:94V-2

◆ COLOR:NATURAL,BLACK

◆ UNIT: mm

用途：作为 PC 板与机板之绝缘用。

RDSC-56 结构图



	PART NO	A	B	C	D	E	PACKAGE
	RDSC-56	3.75	2.65	3.2	5.4	7.0	2000

南京诺金电气有限公司

Nanjing Nowking Electric Co., Ltd



产品名称：绝缘柱

规格型号：RDSC-57

◆ MATERIAL: NYLON 66(UL)

◆ FLAME GLASS:94V-2

◆ COLOR:NATURAL,BLACK

◆ UNIT: mm

用途：作为 PC 板与机板之绝缘用。

RDSC-57 结构图

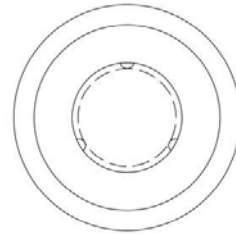
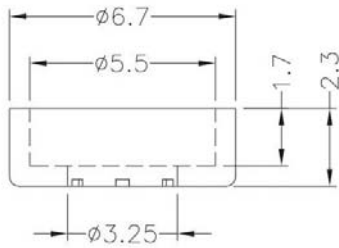

	PART NO	A	B	C	D	E	PACKAGE
	RDSC-57	2.3	1.7	3.25	5.5	6.7	2000

南京诺金电气有限公司

Nanjing Nowking Electric Co., Ltd



产品名称：绝缘柱

规格型号：RDSC-58

- ◆ MATERIAL: NYLON 66(UL)
- ◆ FLAME CLASS: 94V-0, 94V-2
- ◆ COLOR: BLACK, NATURAL
- ◆ UNIT: mm

用途：做为 PC 板与机板之绝缘用。

可使用同等材质

RDSC-58 结构图

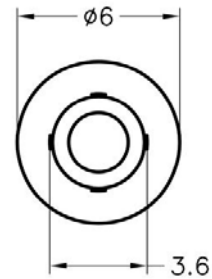
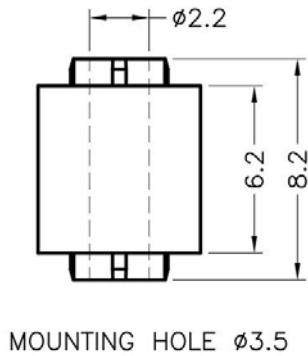

	PART NO	PACKAGE
	RDSC-58	1000

南京诺金电气有限公司

Nanjing Nowking Electric Co., Ltd



产品名称：绝缘柱

规格型号：RDSC-59

- ◆ MATERIAL: NYLON 66(UL)
- ◆ FLAME GLASS:94V-2,94V-0
- ◆ COLOR:NATURAL,BLACK
- ◆ UNIT: mm

用途：作为 PC 板与机板之绝缘用。

RDSC-59 结构图

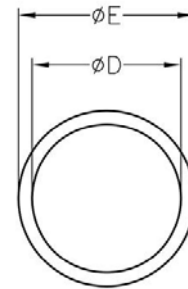
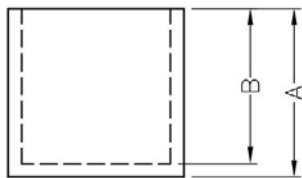

	PART NO	A	B	D	E	PACKAGE
	RDSC-59	5.0	4.6	4.4	5.2	2000

南京诺金电气有限公司

Nanjing Nowking Electric Co., Ltd



产品名称：绝缘柱

规格型号：RDSC-60

- ◆ MATERIAL: PBT (UL)
- ◆ FLAME CLASS: 94V-0
- ◆ COLOR: BLACK, NATURAL
- ◆ UNIT: mm

用途：作为 PC 板与机板之绝缘用。

RDSC-60 结构图

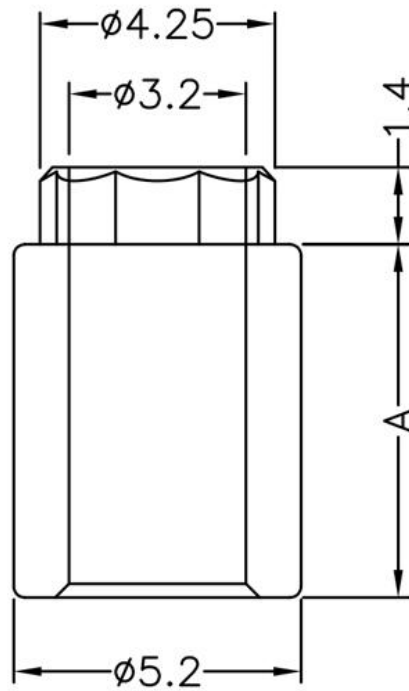

	PART NO	A	PACKAGE
	RDSC-60	7.07	1000

南京诺金电气有限公司

Nanjing Nowking Electric Co., Ltd



产品名称：绝缘柱

规格型号：RDSC-61

- ◆ MATERIAL: PBT (UL)
- ◆ FLAME CLASS: 94V-0
- ◆ COLOR: BLACK, NATURAL
- ◆ UNIT: mm

用途：作为 PC 板与机板之绝缘用。

RDSC-61 结构图

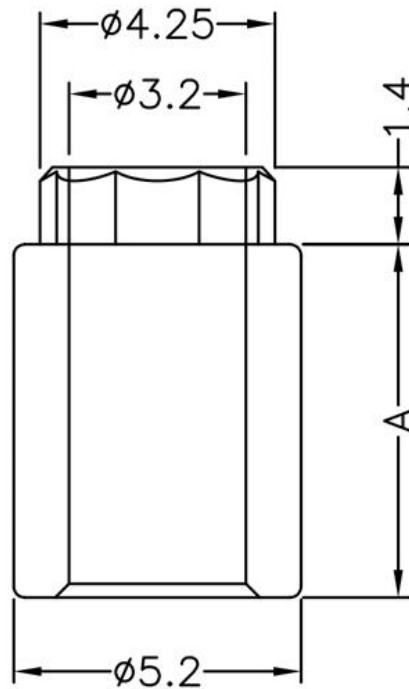

	PART NO	A	PACKAGE
	RDSC-61	9.43	1000

南京诺金电气有限公司

Nanjing Nowking Electric Co., Ltd



产品名称：绝缘柱

规格型号：RDSC-62

- ◆ MATERIAL: PBT (UL)
- ◆ FLAME CLASS: 94V-0
- ◆ COLOR: BLACK, NATURAL
- ◆ UNIT: mm

用途：作为 PC 板与机板之绝缘用。

RDSC-62 结构图

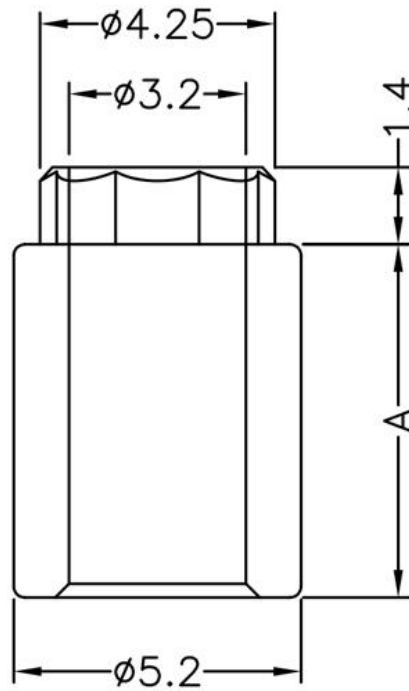

	PART NO	A	PACKAGE
	RDSC-62	10.06	1000