

南京诺金电气有限公司

Nanjing Nowking Electric Co., Ltd

T0-3 电晶体座样本

产品名称: TO-3 电晶体座

规格型号: TO3K-1

◆ MATERIAL: BAKELITE

◆ COLOR: NATURAL

◆ UNIT: mm

用途: 锁于 TO-3 功率晶体与散热片之间, 作为绝缘与保护之用。



TO3K-1 结构图

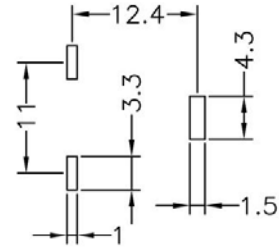
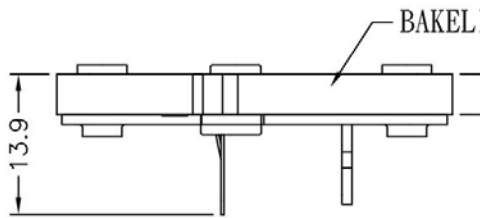

MOUNTING HOLE

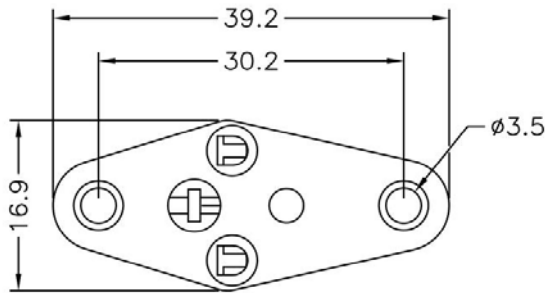

	PART NO	PACKAGE
	TO3K-1	1000

南京诺金电气有限公司

Nanjing Nowking Electric Co., Ltd



产品名称: TO-3 电晶体座

规格型号: TO3K-2

- ◆ MATERIAL: NYLON 66(UL)
- ◆ FLAME CLASS: 94V-0, 94V-2
- ◆ COLOR: NATURAL, BLACK
- ◆ UNIT: mm

用途: 锁于 TO-3 功率晶体与散热片之间, 作为绝缘与保护之用。

TO3K-2 结构图

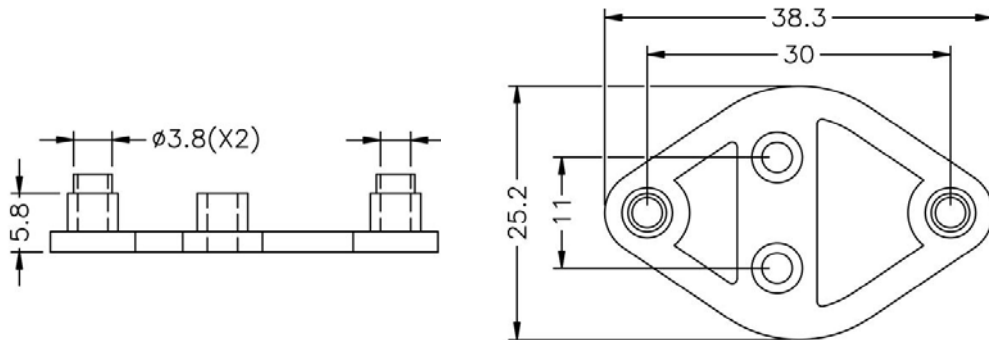

	PART NO	PACKAGE
	TO3K-2	1000

南京诺金电气有限公司

Nanjing Nowking Electric Co., Ltd



产品名称: TO-3 电晶体座

规格型号: TO3K-3

- ◆ MATERIAL: NYLON 66(UL)
- ◆ FLAME CLASS: 94V-0, 94V-2
- ◆ COLOR: NATURAL, BLACK
- ◆ UNIT: mm

用途: 锁于 TO-3 功率晶体与散热片之间, 作为绝缘与保护之用。

TO3K-3 结构图

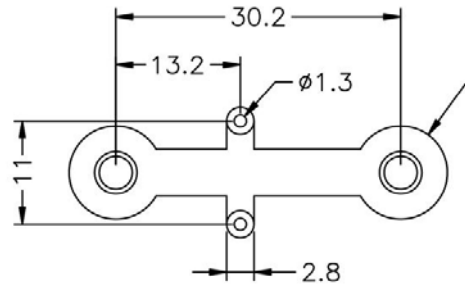
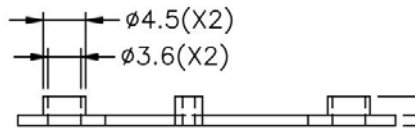

	PART NO	PACKAGE
	TO3K-3	1000

南京诺金电气有限公司

Nanjing Nowking Electric Co., Ltd

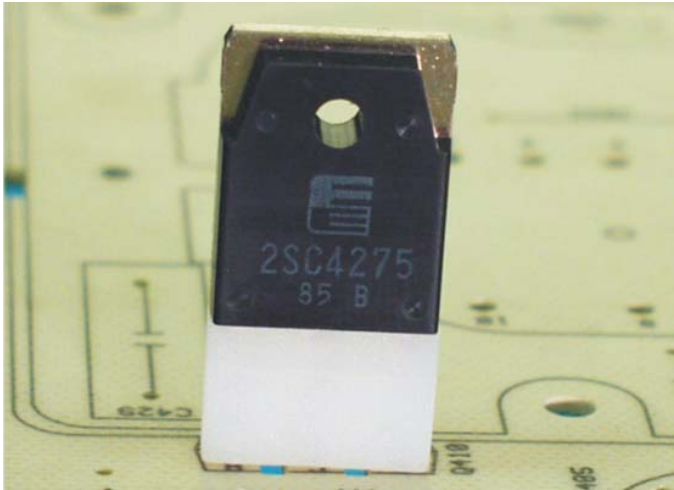

产品名称: TO-3 电晶体座

规格型号: TO3K-4

- ◆ MATERIAL: NYLON 66(UL)
- ◆ FLAME CLASS: 94V-0, 94V-2
- ◆ COLOR: NATURAL, BLACK
- ◆ UNIT: mm

用途: 用于 TO-3P 功率电晶体脚座, 固定高度, 可过锡炉, 美观整齐。

TO3K-4 结构图

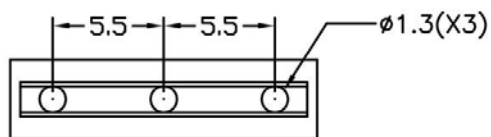
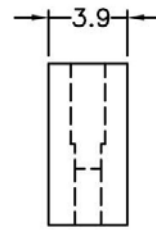
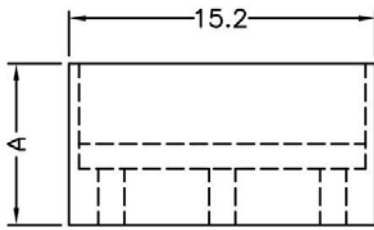

	PART NO	A	PACKAGE
	TO3K-4	8.0	1000

南京诺金电气有限公司

Nanjing Nowking Electric Co., Ltd

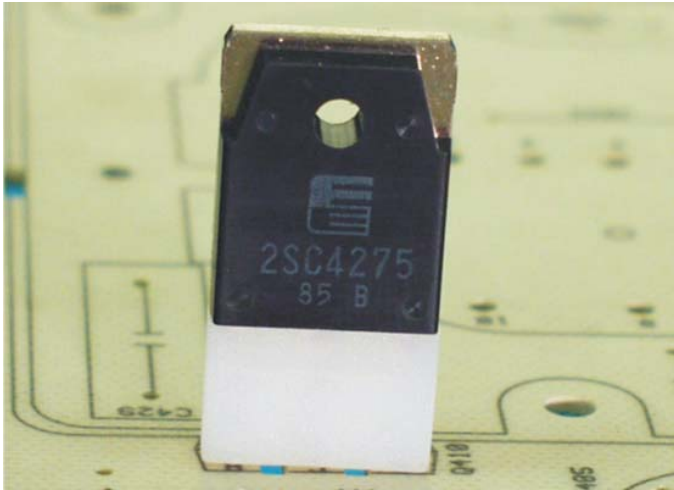

产品名称: TO-3 电晶体座

规格型号: TO3K-5

- ◆ MATERIAL: NYLON 66(UL)
- ◆ FLAME CLASS: 94V-0, 94V-2
- ◆ COLOR: NATURAL, BLACK
- ◆ UNIT: mm

用途: 用于 TO-3P 功率电晶体脚座, 固定高度, 可过锡炉, 美观整齐。

TO3K-5 结构图

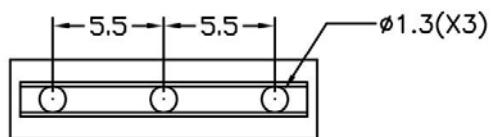
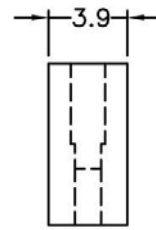
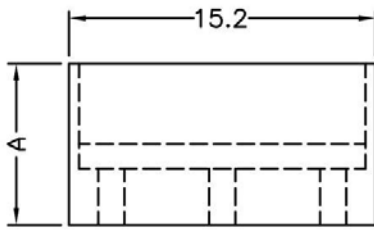

	PART NO	A	PACKAGE
	TO3K-5	10.0	1000

南京诺金电气有限公司

Nanjing Nowking Electric Co., Ltd

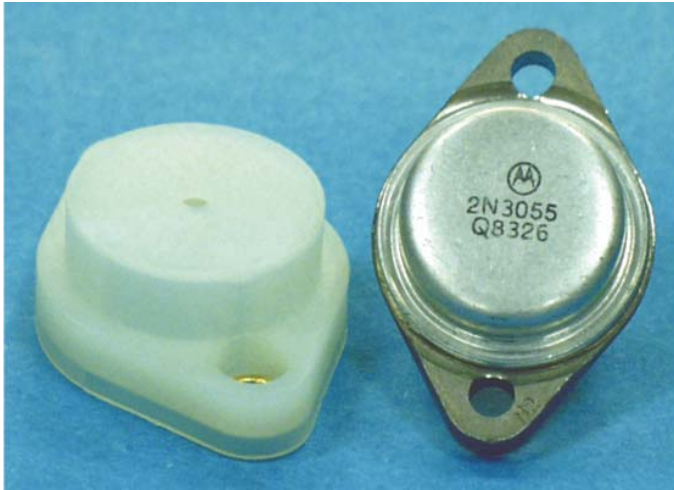

产品名称: TO-3 电晶体座

规格型号: TO3K-6

- ◆ MATERIAL: NYLON 66(UL)
- ◆ FLAME CLASS: 94V-0, 94V-2
- ◆ COLOR: NATURAL, BLACK
- ◆ UNIT: mm

用途: 用于 TO-3 功率晶体之外壳绝缘。

TO3K-6 结构图

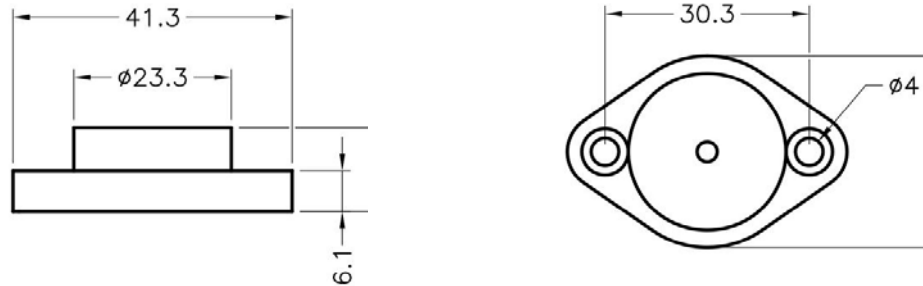

	PART NO	PACKAGE
	TO3K-6	200

南京诺金电气有限公司

Nanjing Nowking Electric Co., Ltd

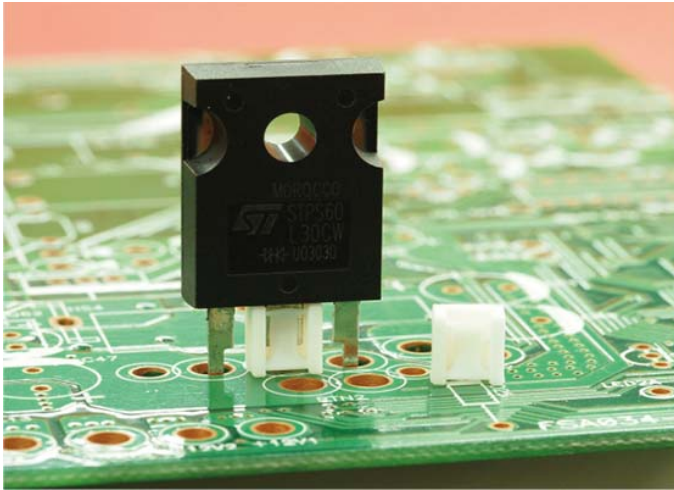

产品名称: TO-3 电晶体座

规格型号: TO3K-7

- ◆ MATERIAL: NYLON 66(UL)
- ◆ FLAME CLASS: 94V-0, 94V-2
- ◆ COLOR: NATURAL, BLACK
- ◆ UNIT: mm

用途: 用于 TO-3P 功率晶体, 保护晶体立于 PC 板上, 使接脚不弯曲、折断、短路、且高度一致。

可使用同等材质

TO3K-7 结构图

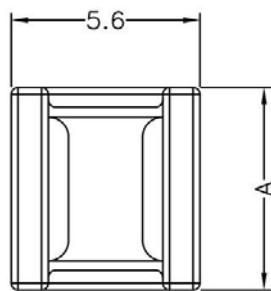
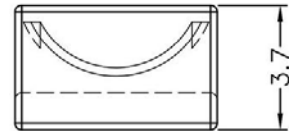
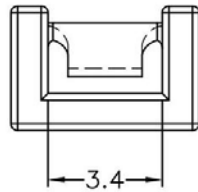

	PART NO	A	PACKAGE
	TO3K-7	4.2	1000

南京诺金电气有限公司

Nanjing Nowking Electric Co., Ltd

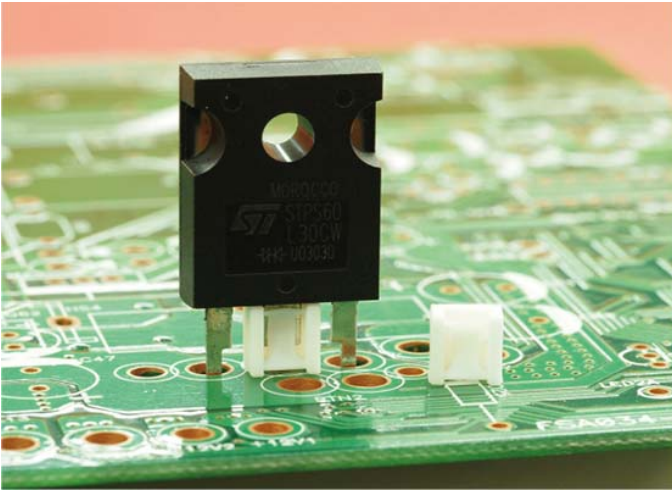

产品名称: TO-3 电晶体座

规格型号: TO3K-8

- ◆ MATERIAL: NYLON 66(UL)
- ◆ FLAME CLASS: 94V-0, 94V-2
- ◆ COLOR: NATURAL, BLACK
- ◆ UNIT: mm

用途: 用于 TO-3P 功率晶体, 保护晶体立于 PC 板上, 使接脚不弯曲、折断、短路、且高度一致。

可使用同等材质

TO3K-8 结构图

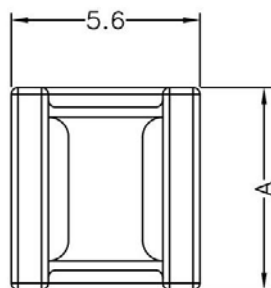
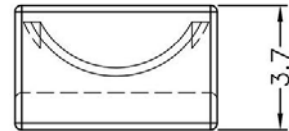
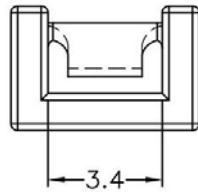

	PART NO	A	PACKAGE
	TO3K-8	6.0	1000

南京诺金电气有限公司

Nanjing Nowking Electric Co., Ltd

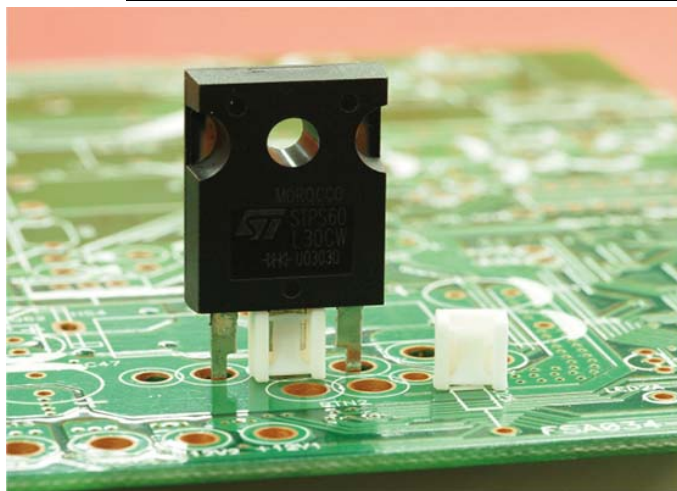

产品名称: TO-3 电晶体座

规格型号: TO3K-9

- ◆ MATERIAL: NYLON 66(UL)
- ◆ FLAME CLASS: 94V-0, 94V-2
- ◆ COLOR: NATURAL, BLACK
- ◆ UNIT: mm

用途: 用于 TO-3P 功率晶体, 保护晶体立于 PC 板上, 使接脚不弯曲、折断、短路、且高度一致。

可使用同等材质

TO3K-9 结构图

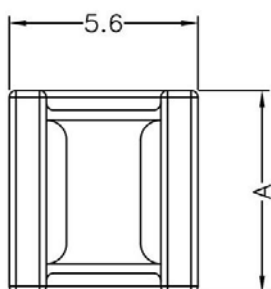
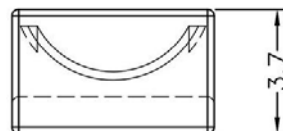
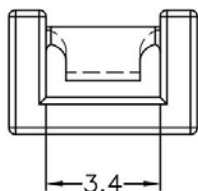

	PART NO	A	PACKAGE
	TO3K-9	4.6	1000