

# 南京诺金电气有限公司

## Nanjing Nowking Electric Co., Ltd

### RJ 防尘盖样本



产品名称: RJ 防尘盖

规格型号: RJ-11-1

- ◆ MATERIAL: PE
- ◆ COLOR: BLACK
- ◆ UNIT: mm

用途: 用于 RJ-11 连接器之防尘盖。

所有尺寸量测皆不含进胶口,胶口凸出 0.3mm

之内

RJ-11-1 结构图

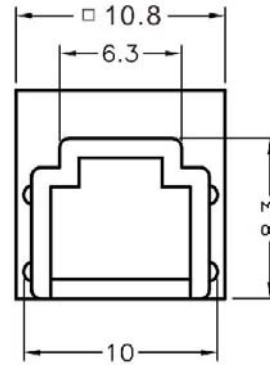
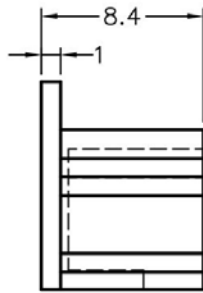

	PART NO	PACKAGE
	RJ-11-1	1000

# 南京诺金电气有限公司

## Nanjing Nowking Electric Co., Ltd



产品名称: RJ 防尘盖

规格型号: RJ-11-2

◆ MATERIAL: PE

◆ COLOR: BLACK

◆ UNIT: mm

用途: 用于 RJ-11 连接器之防尘盖。

所有尺寸量测皆不含进胶口,胶口凸出 0.3mm

之内

RJ-11-2 结构图

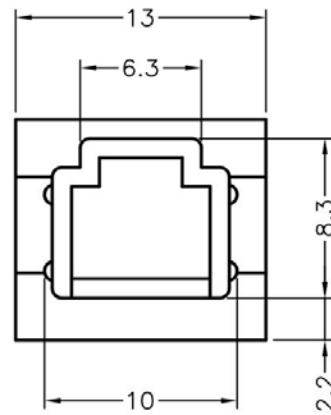
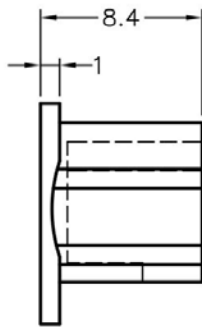

	PART NO	PACKAGE
	RJ-11-2	1000

# 南京诺金电气有限公司

## Nanjing Nowking Electric Co., Ltd

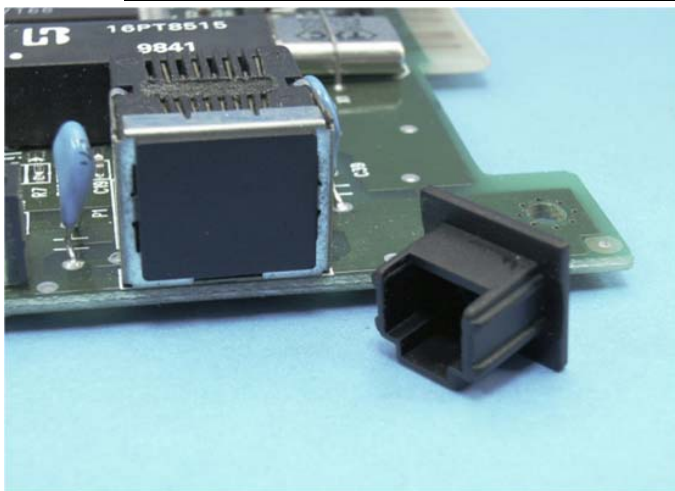

产品名称: RJ 防尘盖

规格型号: RJ-11-3

◆ MATERIAL: PE

◆ COLOR: BLACK

◆ UNIT: mm

用途: 用于 RJ-11 连接器之防尘盖。

所有尺寸量测皆不含进胶口,胶口凸出 0.3mm

之内

RJ-11-3 结构图

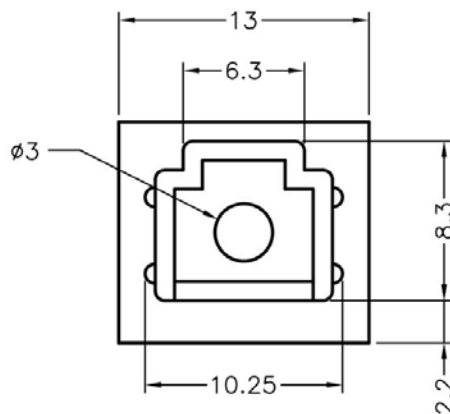
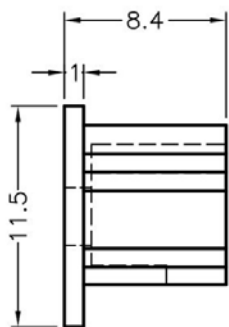

	PART NO	PACKAGE
	RJ-11-3	1000

# 南京诺金电气有限公司

## Nanjing Nowking Electric Co., Ltd



产品名称: RJ 防尘盖

规格型号: RJ-11-4

◆ MATERIAL: PE

◆ COLOR: BLACK

◆ UNIT: mm

用途: 用于 RJ-11 连接器之防尘盖。

所有尺寸量测皆不含进胶口,胶口凸出 0.3mm

之内

RJ-11-4 结构图

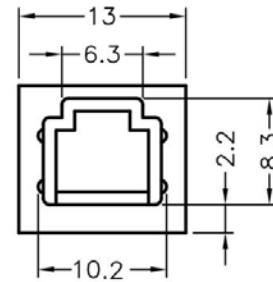
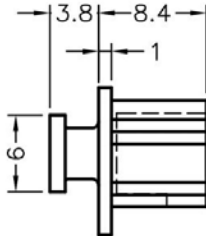

	PART NO	PACKAGE
	RJ-11-4	1000

# 南京诺金电气有限公司

## Nanjing Nowking Electric Co., Ltd



产品名称: RJ 防尘盖

规格型号: RJ-11-5

◆ MATERIAL: PE

◆ COLOR: BLACK

◆ UNIT: mm

用途: 用于 RJ-11 连接器之防尘盖。

所有尺寸量测皆不含进胶口,胶口凸出 0.3mm

之内

RJ-11-5 结构图

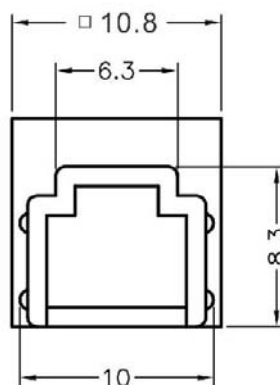
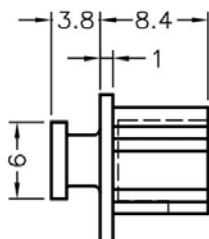

	PART NO	PACKAGE
	RJ-11-5	1000

# 南京诺金电气有限公司

## Nanjing Nowking Electric Co., Ltd

产品名称: RJ 防尘盖

规格型号: RJ-11-6

◆ MATERIAL: SILICON RUBBER

◆ COLOR: BLACK

◆ UNIT: mm

用途: 用于多余的 RJ-11 连接器之防尘, 避免误用。

所有尺寸量测皆不含进胶口, 胶口凸出 0.3mm

之内

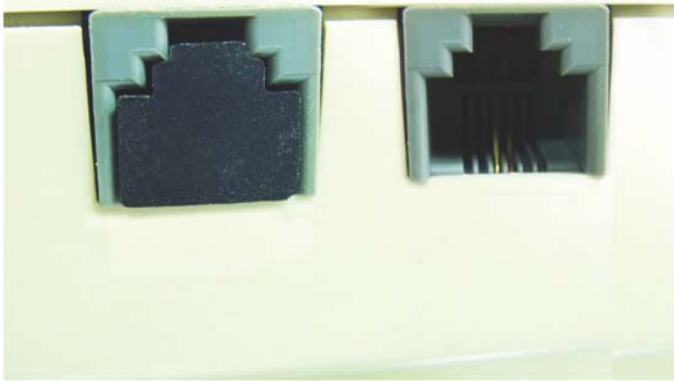

RJ-11-6 结构图

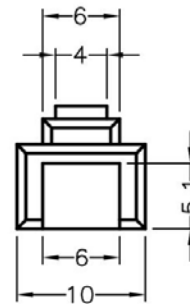
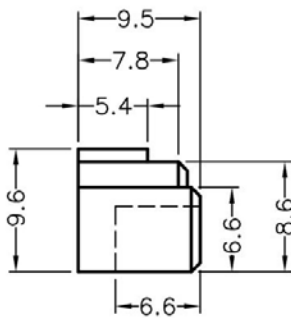

	PART NO	PACKAGE
	RJ-11-6	1000



产品名称: **RJ 防尘盖**

规格型号: **RJ-11-7**

- ◆ MATERIAL: NYLON 66(UL)
- ◆ FALME CALSS: 94V-0, 94V-2
- ◆ COLOR: BLACK, NATURAL
- ◆ UNIT: mm

用途: 用于 RJ-11 连接器之防尘盖。

1. 内缩为正常现象.

2. 可使用同等材质

**RJ-11-7 结构图**

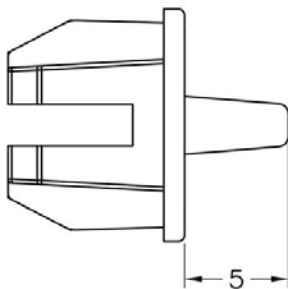
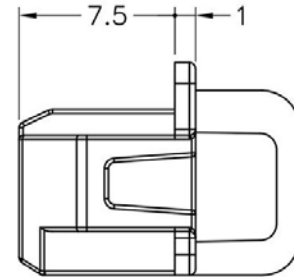
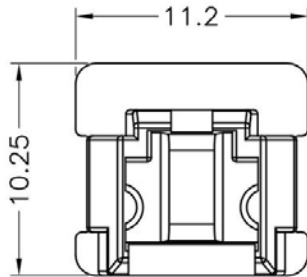

PART NO	PACKAGE
RJ-11-7	1000

# 南京诺金电气有限公司

## Nanjing Nowking Electric Co., Ltd

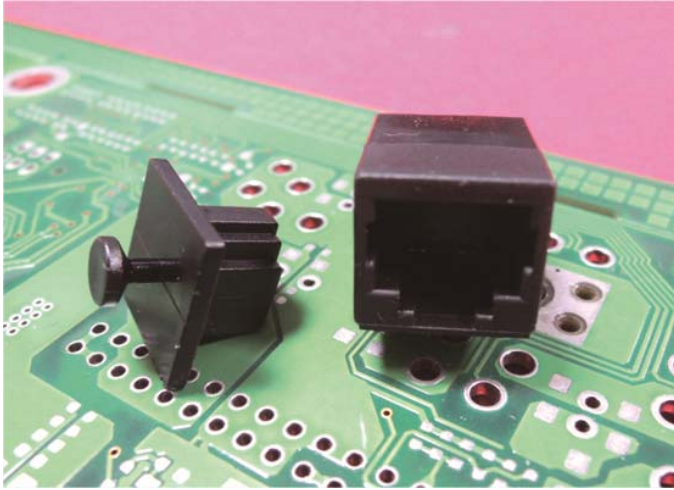

产品名称: **RJ 防尘盖**

规格型号: **RJ-11-8**

- ◆ MATERIAL: NYLON 66(UL)
- ◆ FALME CALSS: 94V-0, 94V-2
- ◆ COLOR: BLACK, NATURAL
- ◆ UNIT: mm

用途: 用于多余的 RJ-11 连接器之防尘, 避免误用。

**RJ-11-8 结构图**

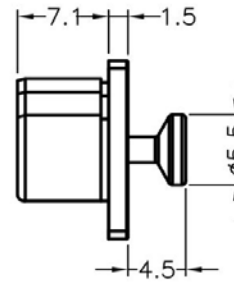
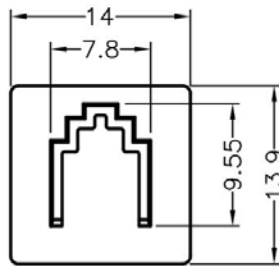

	PART NO	PACKAGE
	RJ-11-8	1000