

D. TYPE 防尘盖



产品名称: D. TYPE 防尘盖

规格型号: D-TYPE-1

◆ MATERIAL: PE

◆ COLOR:BLACK,NATURAL

◆ UNIT:mm

用途: 用于 D.TYPE 连接器之防锈、防尘与保护。。

D-TYPE-1 产品规格图

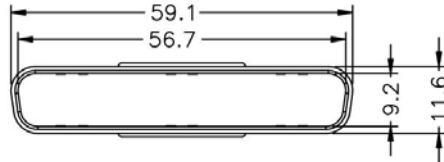

	PART NO	PACKAGE
	D-TYPE-1	1000

南京诺金电气有限公司

Nanjing Noking Electric Co.,Ltd

产品名称: D. TYPE 防尘盖

规格型号: D-TYPE-2

◆ MATERIAL: PP

◆ COLOR:BLACK,NATURAL,COMPUTER

◆ UNIT:mm

用途: 用于 D.TYPE 连接器之防锈、防尘与保护。。

附注: 所有尺寸量测皆不含进胶口,胶口凸出 0.3mm 之内.

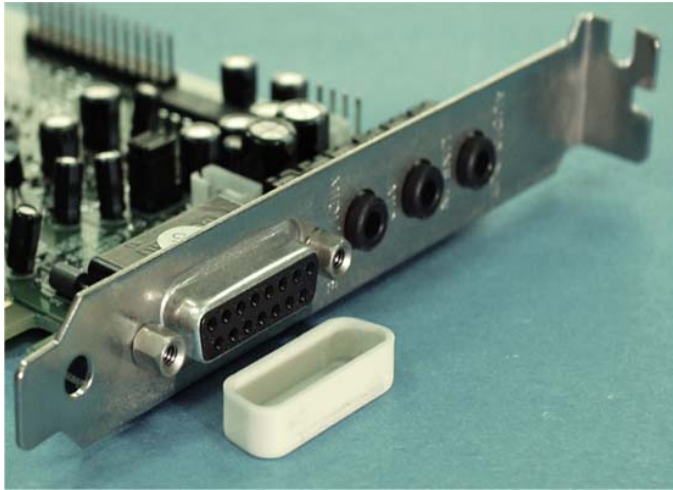

D-TYPE-2 产品规格图

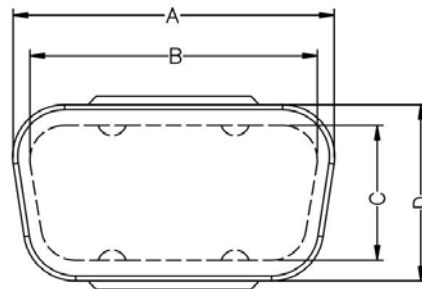
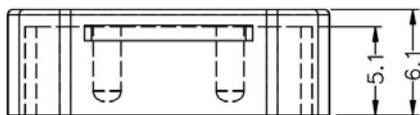

PART NO	A	B	C	D	PACKAGE
D-TYPE-2	18.5	16.5	7.8	10.2	1000

南京诺金电气有限公司

Nanjing Noking Electric Co.,Ltd

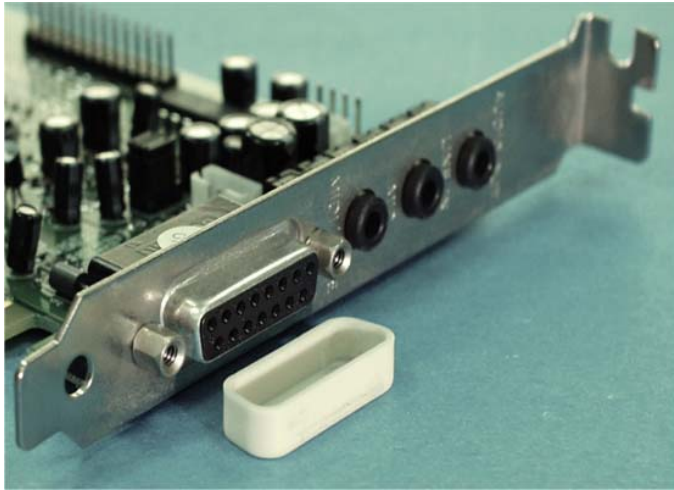

产品名称: D. TYPE 防尘盖

规格型号: D-TYPE-3

◆ MATERIAL: PP

◆ COLOR:BLACK,NATURAL,COMPUTER

◆ UNIT:mm

用途: 用于 D.TYPE 连接器之防锈、防尘与保护。。

附注: 所有尺寸量测皆不含进胶口,胶口凸出 0.3mm 之内.

D-TYPE-3 产品规格图

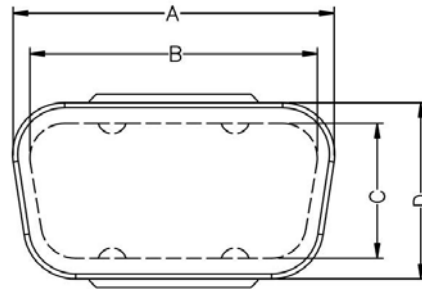
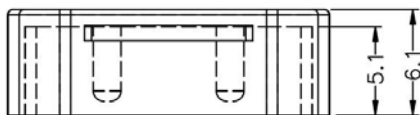

PART NO	A	B	C	D	PACKAGE
D-TYPE-3	20.0	18	9.4	11.8	1000

南京诺金电气有限公司

Nanjing Noking Electric Co.,Ltd

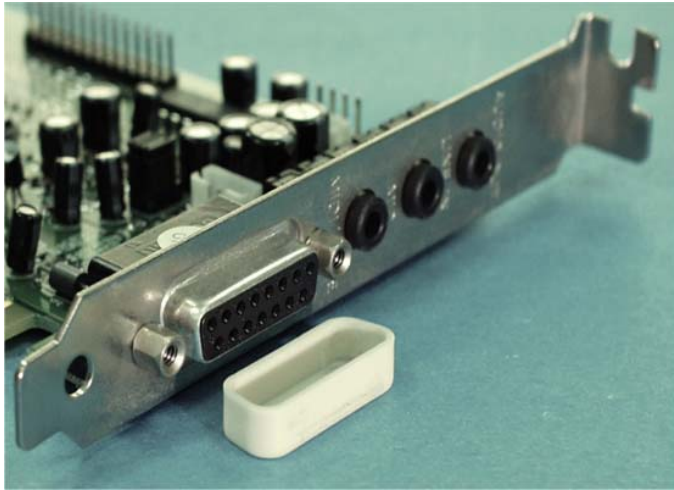

产品名称: D. TYPE 防尘盖

规格型号: D-TYPE-4

◆ MATERIAL: PP

◆ COLOR: BLACK, NATURAL, COMPUTER

◆ UNIT: mm

用途: 用于 D.TYPE 连接器之防锈、防尘与保护。。

附注: 所有尺寸量测皆不含进胶口,胶口凸出 0.3mm 之内.

D-TYPE-4 产品规格图

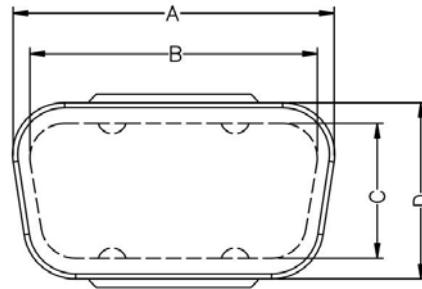
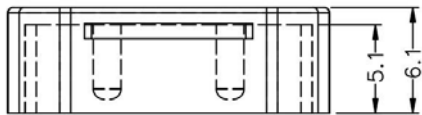

PART NO	A	B	C	D	PACKAGE
D-TYPE-4	26.8	24.8	7.8	10.2	500

南京诺金电气有限公司

Nanjing Noking Electric Co.,Ltd

产品名称: D. TYPE 防尘盖

规格型号: D-TYPE-5

◆ MATERIAL: PP

◆ COLOR:BLACK,NATURAL,COMPUTER

◆ UNIT:mm

用途: 用于 D.TYPE 连接器之防锈、防尘与保护。。

附注: 所有尺寸量测皆不含进胶口,胶口凸出 0.3mm 之内.

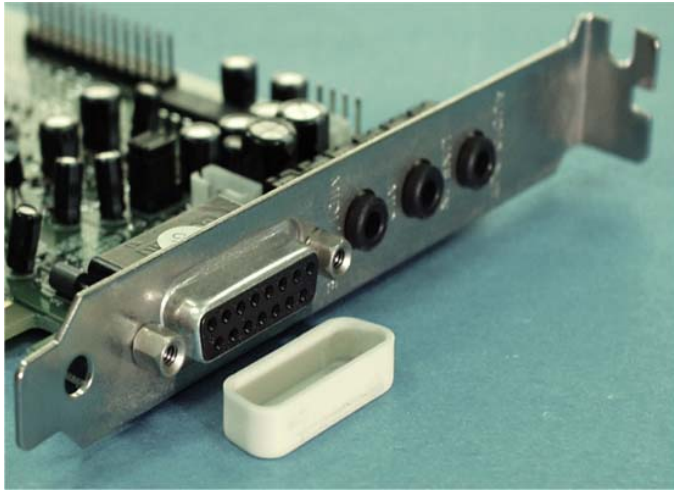

D-TYPE-5 产品规格图

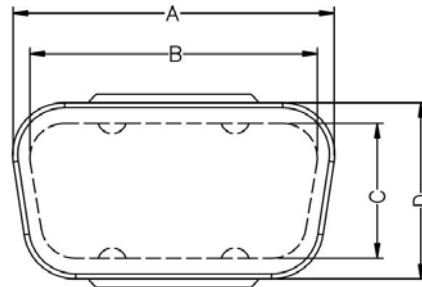
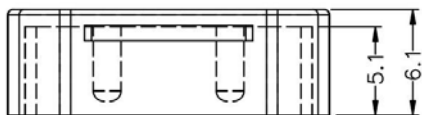

PART NO	A	B	C	D	PACKAGE
D-TYPE-5	28.2	26.4	9.4	11.8	500

南京诺金电气有限公司

Nanjing Noking Electric Co.,Ltd

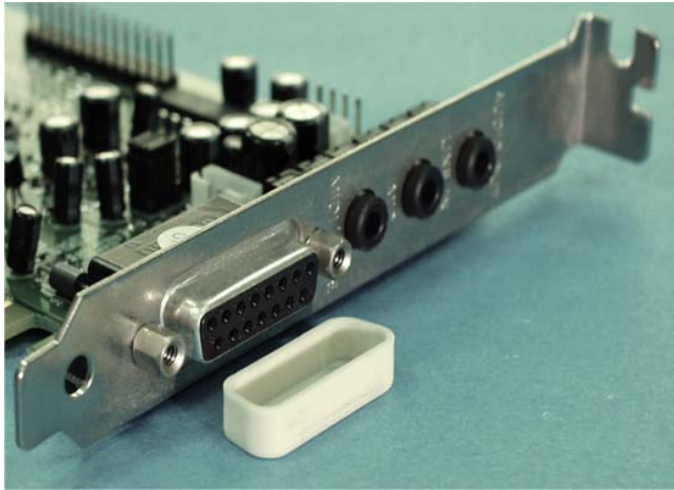

产品名称: D. TYPE 防尘盖

规格型号: D-TYPE-6

◆ MATERIAL: PP

◆ COLOR: BLACK, NATURAL, COMPUTER

◆ UNIT: mm

用途: 用于 D.TYPE 连接器之防锈、防尘与保护。。

附注: 所有尺寸量测皆不含进胶口,胶口凸出 0.3mm 之内.

D-TYPE-6 产品规格图

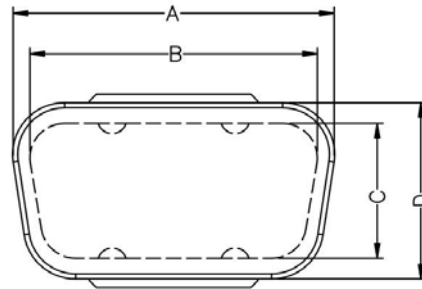
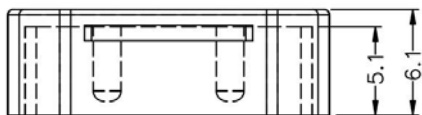

PART NO	A	B	C	D	PACKAGE
D-TYPE-6	40.6	38.6	7.8	10.2	500

南京诺金电气有限公司

Nanjing Noking Electric Co.,Ltd

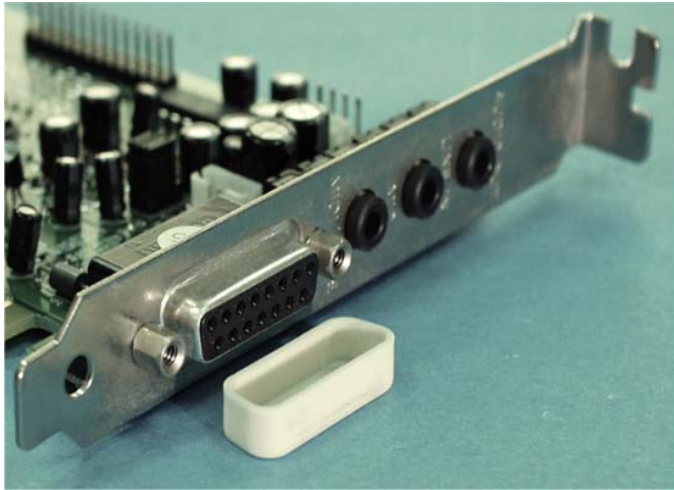

产品名称: D. TYPE 防尘盖

规格型号: D-TYPE-7

◆ MATERIAL: PP

◆ COLOR:BLACK,NATURAL,COMPUTER

◆ UNIT:mm

用途: 用于 D.TYPE 连接器之防锈、防尘与保护。。

附注: 所有尺寸量测皆不含进胶口,胶口凸出 0.3mm 之内.

D-TYPE-7 产品规格图

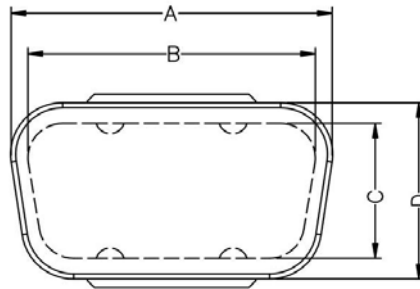
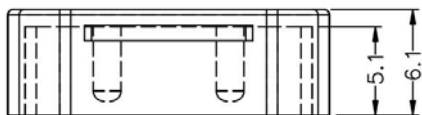

PART NO	A	B	C	D	PACKAGE
D-TYPE-7	42	40	9.4	11.8	500

产品名称: D. TYPE 防尘盖

规格型号: D-TYPE-8

◆ MATERIAL: PP(UL)

◆ FLAME CLASS: 94HB

◆ COLOR:BLACK,TRANSPARENT

◆ UNIT:mm

用途: 用于 D.TYPE 连接器之防锈、防尘与保护。



D-TYPE-8 产品规格图

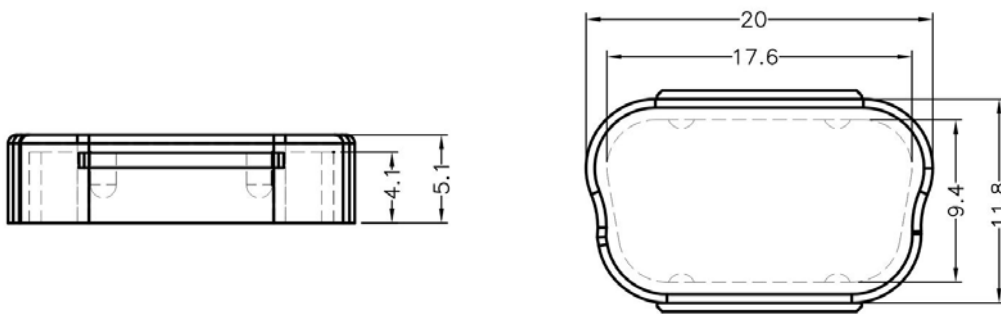

	PART NO	PACKAGE
	D-TYPE-8	1000

产品名称: D. TYPE 防尘盖

规格型号: D-TYPE-9

◆ MATERIAL: NYLON 66(UL)

◆ FLAME CLASS: 94V-0, 94V-2

◆ COLOR:BLACK,NATURAL

◆ UNIT:mm

用途: 用于 D.TYPE 连接器之防锈、防尘与保护。



D-TYPE-9 产品规格图

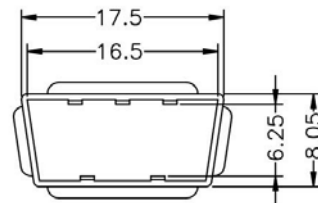

	PART NO	PACKAGE
	D-TYPE-9	1000

产品名称: D. TYPE 防尘盖

规格型号: D-TYPE-10

◆ MATERIAL: NYLON 66(UL)

◆ FLAME CLASS: 94V-0, 94V-2

◆ COLOR:BLACK,NATURAL

◆ UNIT:mm

用途: 用于 D.TYPE 连接器之防锈、防尘与保护。



D-TYPE-10 产品规格图

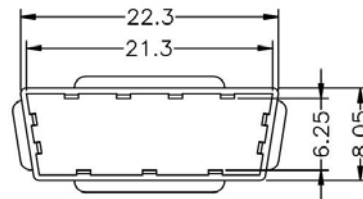
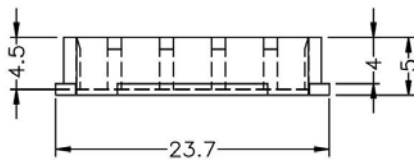

	PART NO	PACKAGE
	D-TYPE-10	1000

南京诺金电气有限公司

Nanjing Noking Electric Co.,Ltd

产品名称: D. TYPE 防尘盖

规格型号: D-TYPE-11

◆ MATERIAL: PE

◆ COLOR:BLACK,NATURAL,COMPUTER

◆ UNIT:mm

用途: 用于 D.TYPE 连接器之防锈、防尘与保护。



D-TYPE-11 产品规格图

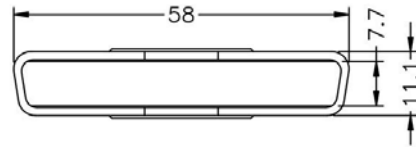
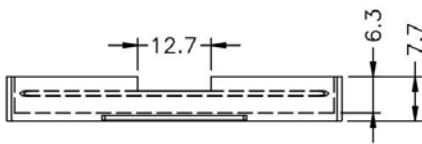

	PART NO	PACKAGE
	D-TYPE-11	250

产品名称: D. TYPE 防尘盖

规格型号: D-TYPE-12

◆ MATERIAL: PE

◆ COLOR:BLACK,NATURAL,COMPUTER

◆ UNIT:mm

用途: 用于 D.TYPE 连接器之防锈、防尘与保护。



D-TYPE-12 产品规格图

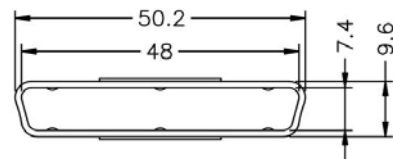
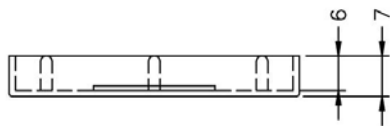

	PART NO	PACKAGE
	D-TYPE-12	500

南京诺金电气有限公司

Nanjing Noking Electric Co.,Ltd

产品名称: D. TYPE 防尘盖

规格型号: D-TYPE-13

◆ MATERIAL: PE

◆ COLOR:BLACK,NATURAL,COMPUTER

◆ UNIT:mm

用途: 用于 D.TYPE 连接器之防锈、防尘与保护。



D-TYPE-13 产品规格图

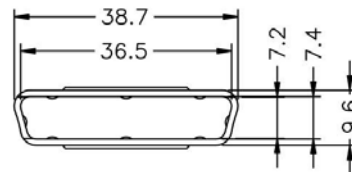
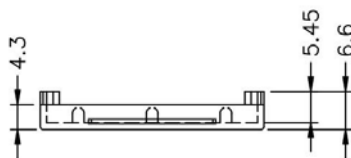

	PART NO	PACKAGE
	D-TYPE-13	500

产品名称: D. TYPE 防尘盖

规格型号: D-TYPE-14

◆ MATERIAL: PE

◆ COLOR:BLACK,NATURAL,COMPUTER

◆ UNIT:mm

用途: 用于 D.TYPE 连接器之防锈、防尘与保护。



D-TYPE-14 产品规格图

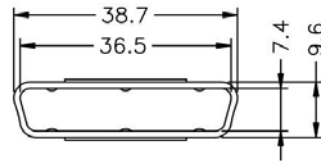
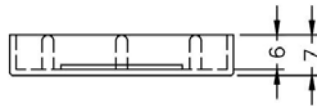

	PART NO	PACKAGE
	D-TYPE-14	500